

INDUSTRIAL HOSES - peristaltic pumps

Peristaltic pump

Peristaltic pump - positive displacement pump of a special construction. There are two main groups of peristaltic pumps: roller pumps and sliding shoe pumps.

In the case of the first group, a rotor with a number of rollers rotates. Each roller compresses the hose walls. Then, once the roller passes, the hose regains its original shape. This type of pumps basically runs dry, only the hose is lubricated with silicone grease.

The second type of pumps operates in a similar way. But in this case, a rotor with a number of shoes rotates. The hose is compressed by shoes. The hose is in a pump chamber with neutral oil (usually glycerin). The oil lubricates and cools the flexible hose as it reduces a major source of heat - friction that occurs between the hose surface and shoes during pumping.

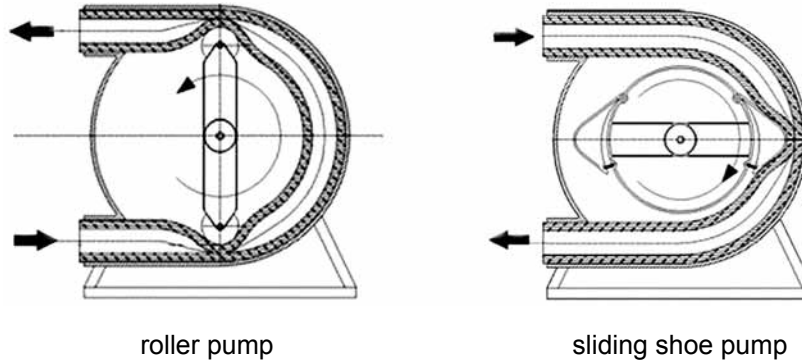

Hose

Application of peristaltic pumps eliminates any extra connections between hose assemblies and reduces down to the minimum dead volume between the fluid tanks that are pumped. Only one hose assembly can be used for the transfer. Some parts of the hose are then used as an input hose and some parts as a working length in the pump. The walls of the working hose length must be highly flexible so the hose closes or its diameter is at least reduced under roller or shoe compression.

The mechanical features of the hose and material it is made of are determining factors which influence the efficiency of the peristaltic pump:

- flexibility - enables suction of fluids, decides on machine's ability to maintain constant flow, resistance to compression and chemical resistance to the medium determines hose service life and thus pump's reliability.

In order to select a proper hose (spare part) for the pump, the following information must be supplied:







- is the external layer of the hose currently used rough or maybe very smooth,
- what is the internal and external hose diameter,
- how long is the hose,
- are the hose fittings extended, what is their internal and external diameter or length?

Application

food industry	cosmetic industry	chemical industry	construction industry
milk, yoghurt, ice-cream, fruit juices, beverages, syrup, jam, chocolate, eggs, sauce, oils, fats	soap, toothpaste, shampoo, conditioner, hair dye, lotion, cream	acids and bases in suspension, caustic soda, rubber milk, resin, adhesives, detergents, solvents, colorants, bleachers	sludge, silt, paints, colorants, varnish, distilled water, limewater, mortar, bentonite, cement additives, slurry, wastewater

INDUSTRIAL HOSES - peristaltic pumps

A special design hose should be properly selected depending on application and medium to be transferred.

picture	hose type	description
	PERISTALTIC / NR	Hose for the transfer of abrasive products, non-aggressive fluids, fluids with solid particles (suspension). Internal layer: black NR rubber, External layer: black NR rubber, Working temp.: from -10°C up to +80°C.
	PERISTALTIC / NR-food	Hose for the transfer of abrasive products, non-aggressive fluids, fluids with solid particles (suspension). A hose version intended for foodstuffs transfer, approved by FDA. Internal layer: white NR rubber, External layer: black NR rubber, Working temp.: from -10°C up to +80°C.
	PERISTALTIC / NBR	Hose for the transfer of oils and fatty products, including mineral oils. Internal layer: black NBR rubber, External layer: black NBR rubber, Working temp.: from -10°C up to +80°C.
	PERISTALTIC / NBR-food	Hose for the transfer of oils and fatty products, including mineral oils. A hose version intended for foodstuffs transfer, approved by FDA. Internal layer: white NBR rubber, External layer: black NBR rubber, Working temp.: from -10°C up to +80°C.
	PERISTALTIC / HNBR	Hose for the transfer of mineral oils, fuels, petrochemical products with aromatic content up to 60%. Internal layer: black HNBR rubber, External layer: black HNBR rubber, Working temp.: from +15°C up to +150°C.
	PERISTALTIC / EPDM	Hose for the transfer of various chemical fluids. Internal layer: black EPDM rubber, External layer: black EPDM rubber, Working temp.: from -10°C up to +100°C.
	PERISTALTIC / CSM	Hose for the transfer of various chemical fluids. Internal layer: black CSM rubber, External layer: black CSM rubber, Working temp.: from -10°C up to +80°C.