

HIGH PRESSURE - DIN 2353 connectors

Characteristics and applications

Threaded (pipe) fittings with 24° cone sealing and cutting ring are widely used in many branches of industry to connect steel pipes with outside diameter from 4 to 42 mm. Fittings according to DIN 2353 can also be used to connect flexible hose assemblies (as a body without nut and cutting ring). Manufactured according to ISO 8437-1 or DIN 2353. Used in hydraulic and pneumatic drive and control systems as well as general industrial applications.

Operation principle of fittings with a cutting ring

A complete connection of a pipe with a hydraulic installation requires: a fitting (1), a cutting ring (2), a nut (3) and a hydraulic precision pipe (4). During assembly, sharp edges of the ring (5 and 6) bite into the pipe according to the 24° cone (7) and creating a "shoulder" (9). The pipe, cut straight at 90° angle, must be pushed firmly against the bottom of the seat (10). Otherwise, the cutting ring does not bite into the pipe deep enough to create a tight connection

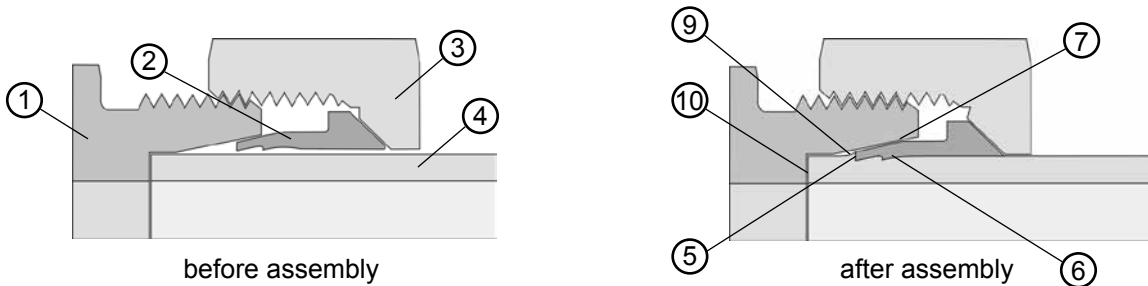

The fittings manufactured according to DIN 2353, depending on their usage and pressure, can be divided into the following categories:

- LL (extra light series) - used in small hydraulic and cooling devices, for plastic hoses, compressed air, propane, etc.
- L (light series) - used for standard applications within the working pressure of that range.
- S (heavy series) - used for higher pressure, hydraulic high pressure applications such as: hammering, shipbuilding, mining, chemical industry, heavy equipment.

To identify DIN2353 fitting, a seat "D" (that defines pipe outside diameter), and thread size "M" (metric thread is a standard) must be measured. The table below presents all information needed for quick and easy identification of the range and module number used in a code number at TUBES INTERNATIONAL®. For example: fitting with D = 10 mm and thread size M16x1.5 corresponds to a light range and 10L module.

picture	pipe D [mm]	thread size M [mm]	series	module	
	4	M8x1	LL (extra light)	4LL	
	6	M10x1		6LL	
	8	M12x1		8LL	
		6	M12x1.5	L (light)	6L
		8	M14x1.5		8L
		10	M16x1.5		10L
		12	M18x1.5		12L
		15	M22x1.5		15L
		18	M26x1.5		18L
		22	M30x2		22L
28		M36x2	28L		
35		M45x2	35L		
42		M52x2	42L		
	6	M14x1.5	S (heavy)	6S	
	8	M16x1.5		8S	
	10	M18x1.5		10S	
	12	M20x1.5		12S	
	14	M22x1.5		14S	
	16	M24x1.5		16S	
	20	M30x2		20S	
	25	M36x2		25S	
	30	M42x2		30S	
	38	M52x2		38S	

HIGH PRESSURE - DIN 2353 connectors

Basic information

Material

DIN 2353 pipe fittings are supplied in two material versions:

- carbon steel (zinc-plated or phosphate-coated) standard seal: NBR rubber,
- stainless steel (AISI 316) standard seal: Viton.

Working temperature

Allowable working temp. depends on the material of a connector and seal:

- carbon steel: from -40°C up to +120°C
- carbon steel + NBR: from -35°C up to +100°C
- stainless steel: from -60°C up to +400°C
- stainless steel + Viton: from -20°C up to +200°C

Working Pressure

The max. working pressure (nominal pressure) of DIN 2353 pipe fittings differs according to the type (light series, heavy series), size (pipe outside diameter), material and manufacturer. In the table below, data from different producers showing different types of fittings, made of carbon and stainless steel, is collected. It facilitates preliminary selection. If the required working pressure exceeds the value in the table, please contact TUBES INTERNATIONAL® Technical Department.

series	pipe O.D. [mm]	maximum working pressure [bar]		
		for connection with cutting ring according to PN-ISO 8434-1	for complete fitting according to different producers	
			minimum	maximum
LL	4 ÷ 8	100		
L	6 ÷ 15	250	160	400
	18 ÷ 22	160	100	315
	28 ÷ 42	100	100	250
S	6 ÷ 12 (14)	630	400	630
	16 ÷ 25	400	250	400
	30 ÷ 38	250	250	315

Nominal pressure (max working pressure) given by manufacturers is calculated within static working conditions, the safety factor of 4 for the cutting ring connection. For fittings with metal to metal seal and BANJO fittings, the safety factor varies from 1.5 to 2.5. When choosing a fitting, dynamic pressure load and vibrations in the installation should be also considered.

For temperatures above +100°C, the max. working pressure may require reduction (contact TUBES INTERNATIONAL® Technical Department).

Medium

Pipe fittings according to DIN 2353 can be used to transfer a wide range of fluids and gases. However, the compatibility of the medium with fitting material and seal type must be always checked. For all applications different from standard hydraulic oils, please contact TUBES INTERNATIONAL® Technical Department.

Pipes used in installations

Pipes used for the construction of installations,

- seamless steel precision pipes, protected against corrosion (phosphate-coated, zinc-plated), annealed,
- stainless steel precision pipes, cold-drawn, free of annealing scale, heat treated (annealed).

Pipe dimensions (outside diameter, wall thickness) should be chosen according to the required flow rate and working pressure in an installation.

HIGH PRESSURE - DIN 2353 connectors

Identification of DIN 2353 pipe fitting

Fittings according to DIN 2353 have up to 4 different connection ends joining them with the remaining part of the installation. The two most common are:

- connectors with 24° cone or a connection end designed for the connection with 24° cone,
- connectors with one end designed to be screwed into the body (of a particular equipment or machine).

Connectors with 24° cone

1) Designed to be connected with a pipe with D outside diameter. The parts connect when a cutting ring with D inside diameter is pressed down by a tightening nut with M female thread (code HD-M...).

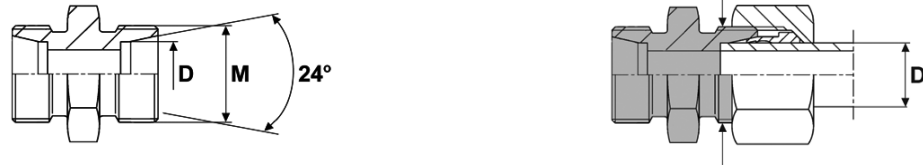

This connection end corresponds exactly to the end fitting of flexible hydraulic hoses such as (code: TI-ZMZ111... - light series and TI-ZMZ112... - heavy series).

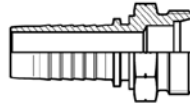

2) Fitting end mating the cone with swivel nut on a conical thread with an additional O-ring.



This connection end corresponds exactly to the end fitting of flexible hydraulic hoses type (code: TI-ZMZ111... - light series and TI-ZMZ112... - heavy series).

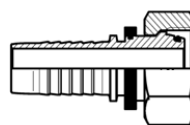

3) Fitting end mating the cone with swivel nut on a pipe end with a cutting ring and a nut.



This connection end corresponds exactly to the end fitting of flexible hydraulic hoses such as (code: TI-ZMZ111... - light series and TI-ZMZ112... - heavy series), additionally with a cutting ring.

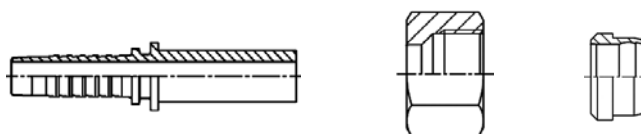

HIGH PRESSURE - DIN 2353 connectors

Connectors - with male thread, designed to be screwed into the body

A connection end designed to be screwed into the body (of a particular equipment or machine) is identified by the size of a G male thread as well as sealing type.

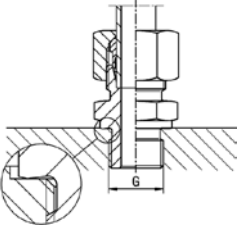
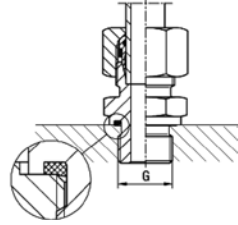
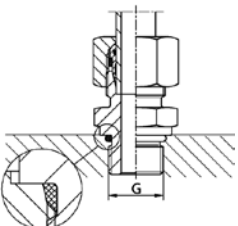
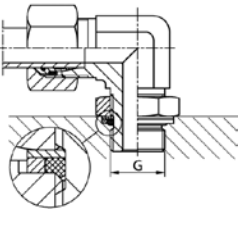
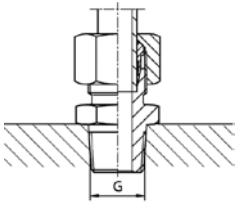
picture	seal type	G-type threaded screw	safety factor
<p>DIN3852 B type</p> 	metal to metal seal	<ul style="list-style-type: none"> - BSP parallel thread - metric parallel thread 	2.5 : 1
<p>DIN3852 E type</p> 	elastomeric seal (rectangular shape)	<ul style="list-style-type: none"> - BSP parallel thread - metric parallel thread 	4 : 1
<p>ISO 11926</p> 	O-ring seal	- UNF-UN	4 : 1
<p>ISO 1179 G type ISO 6149 G type</p> 	O-ring seal with retaining ring	<ul style="list-style-type: none"> - BSP parallel thread - metric parallel thread 	4 : 1
<p>DIN 3852 ANSI / ASME</p> 	thread seal PTFE tape or anaerobic sealant	<ul style="list-style-type: none"> - BSPT - metric cone thread - NPT 	2.5 : 1

HIGH PRESSURE - DIN 2353 connectors

Connectors - with male thread - designed to be screwed into the body

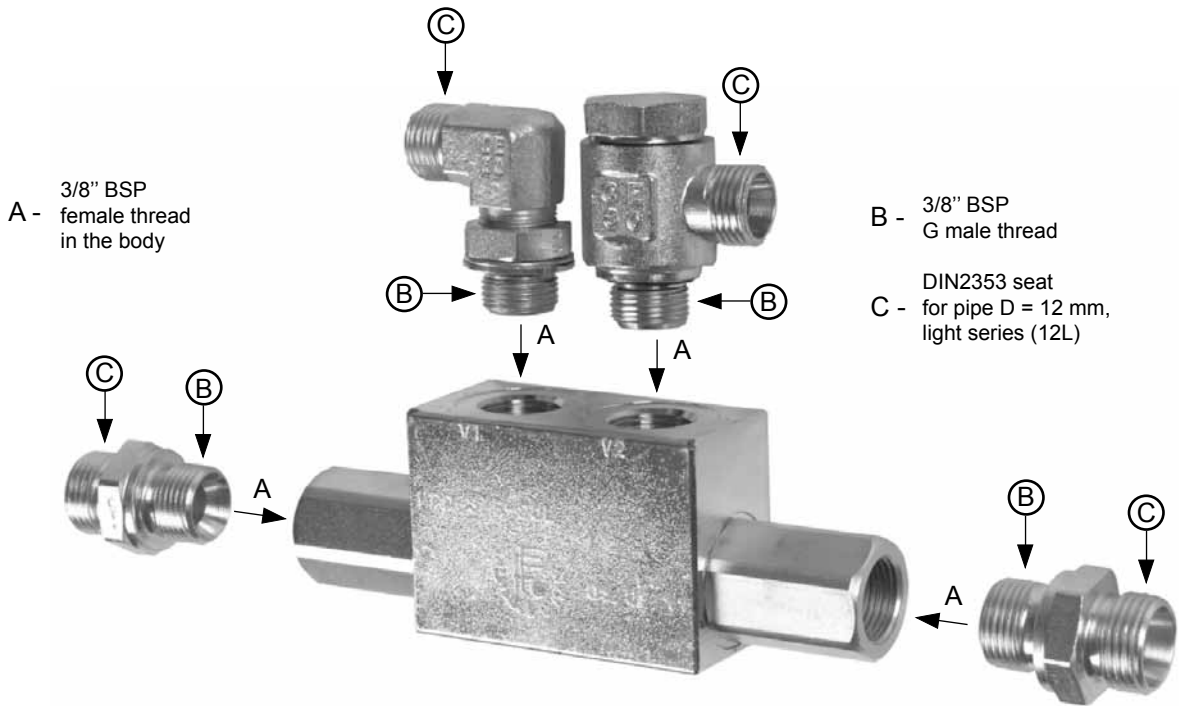

An example of DIN 2353 connectors used with a valve with imperial female thread is presented above. The table below shows the range of G male thread pipe sizes in their most common combination with DIN 2353 connectors (pipe size and series).

picture	module	pipe O. D. [mm]	series type	G thread male pipe sizes				
				BSP and NPT threads (parallel and taper)	metric threads (parallel and taper)	UN-UNF threads		
	6L	6	L (light)	1/8	M10x1	7/16-20		
	8L	8		1/4	M12x1.5	1/2-20		
	10L	10		1/4	M14x1.5	1/2-20		
	12L	12		3/8	M16x1.5	9/16-20		
	15L	15		1/2	M18x1.5	3/4-16		
	18L	18		1/2	M22x1.5	3/4-16		
	22L	22		3/4	M26x1.5	1.1/16-12		
	28L	28		1	M33x2	1.5/16-12		
	35L	35		1.1/4	M42x2	1.5/8-12		
	42L	42		1.1/2	M48x2	1.7/8-12		
		6S		6	S (heavy)	1/4	M12x1.5	1/2-20
		8S		8		1/4	M14x1.5	1/2-20
10S		10	3/8	M16x1.5		9/16-20		
12S		12	3/8	M18x1.5		9/16-20		
14S		14	1/2	M20x1.5		3/4-16		
16S		16	1/2	M22x1.5		3/4-16		
20S		20	3/4	M27x2		1.1/16-12		
25S		25	1	M33x2		1.5/16-12		
30S		30	1.1/4	M42x2		1.5/8-12		
38S		38	1.1/2	M48x2		1.7/8-12		

HIGH PRESSURE - DIN 2353 connectors

DIN 2353 fittings assembly manual

1. Before start, check whether all tools are free from damage.
2. The length of a pipe should be at least twice as long as tightening nut (H length). The roundness of the pipe should meet DIN 2391 standard.
3. Pipe should be cut at 90° angle using a metal cutting saw (roll pipe cutters must not be used). Check the cut angle and deburr internally and externally.
4. Lubricate the inside of the 24° cone seat, thread, tightening nut and cutting ring.
5. Assemble the nut and cutting ring on the pipe as indicated in the picture. Ensure that the head of the cutting ring (thicker end) faces the tightening nut.
6. Push the pipe against the shoulder of the 24° cone of the body. Screw the nut manually until it is finger tight and then tighten the nut with a spanner until the cutting edge of the cutting ring starts to bite into the pipe. The pipe must not rotate during this part of assembly!
7. Push the pipe firmly against the bottom of the cone seat, tighten the nut with a spanner by about 3/4 turn. The nut and the body can be marked to assure the 3/4 turn. While tightening, the cutting ring bites into the pipe creating a "collar" just in front of the ring. Tightening too strong or too weak, weakens the connection and may cause leakage or loosening of the pipe.
8. Loosen the nut, take out the pipe and check whether the collar in front of the cutting ring edge is visible. The collar has to be visible on at least 80% of the pipe circumference. Check if the cutting ring is firmly tightened on the pipe and cannot move alongside. If the grip is not tight enough, the preassembly must be repeated.
9. If the preassembly was correct, push the pipe against the bottom, tighten again about 1/4 turn beyond the point of clearly perceptible resistance. While tightening the body must be held firm by a spanner or a vice.
10. Preassembly of stainless steel fittings should be performed using special tools.

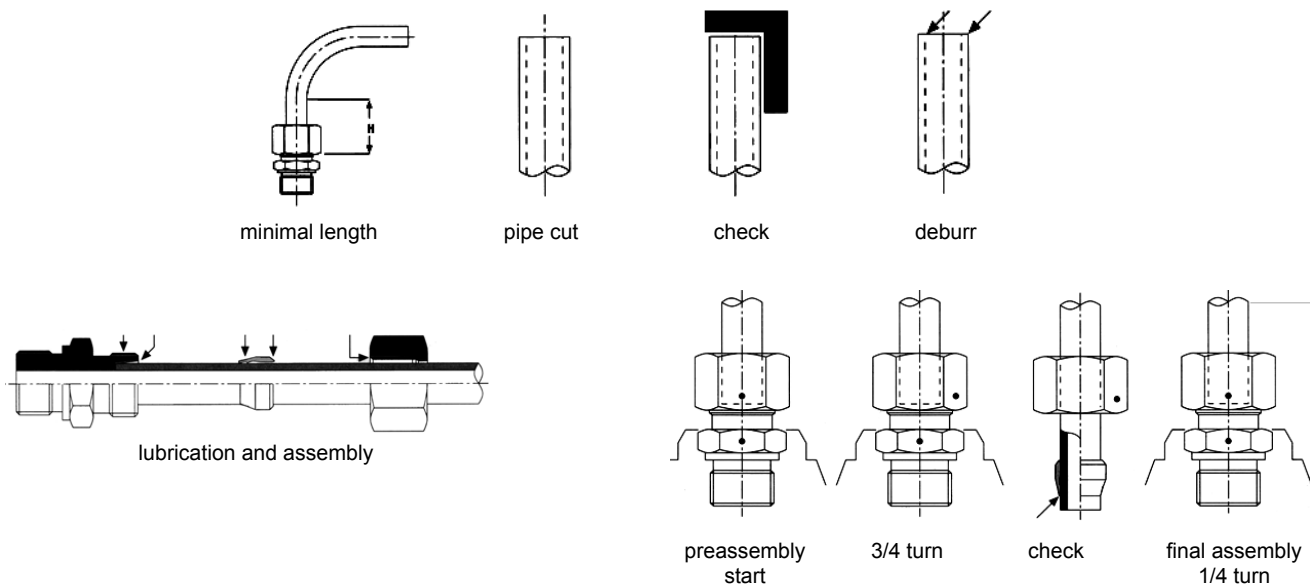

Assembly machines for DIN 2353 rings

Pre-assembly of DIN2353 cutting rings on hydraulic pipes can be performed on special machines made for that purpose (see chapter MACHINES AND ACCESSORIES - hose assembly production).



HIGH PRESSURE - DIN 2353 connectors

Codes of connectors in the catalogue

Connectors are marked with special codes in our catalogue - they should be used when placing an order.

Code example:

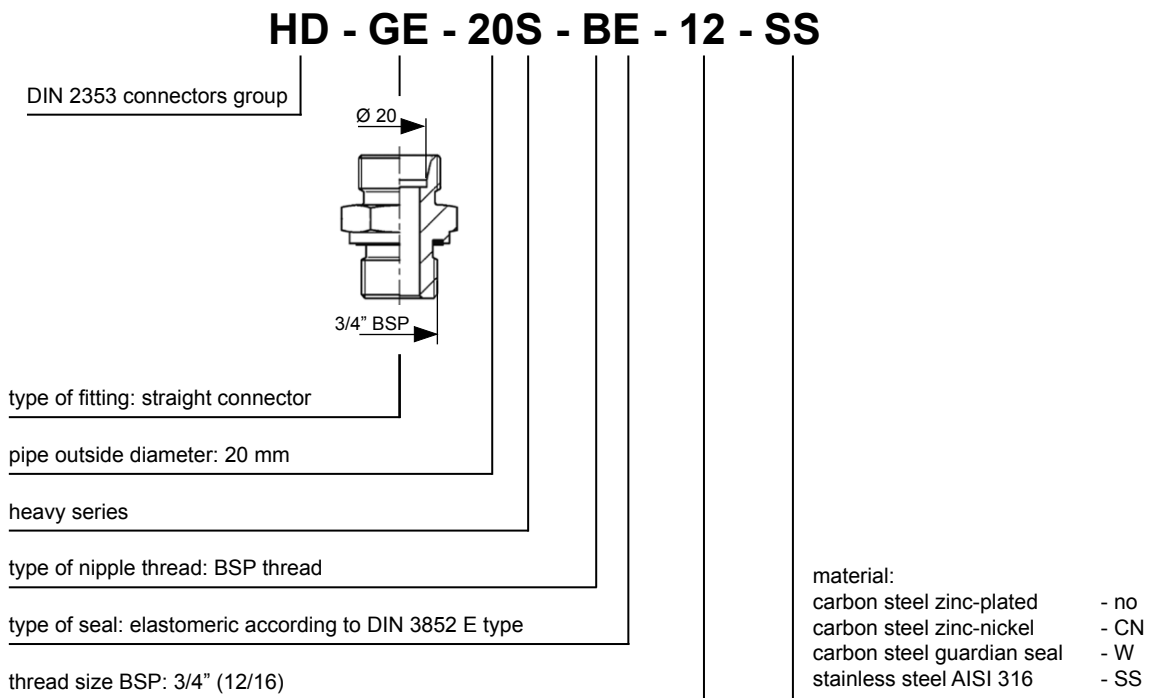
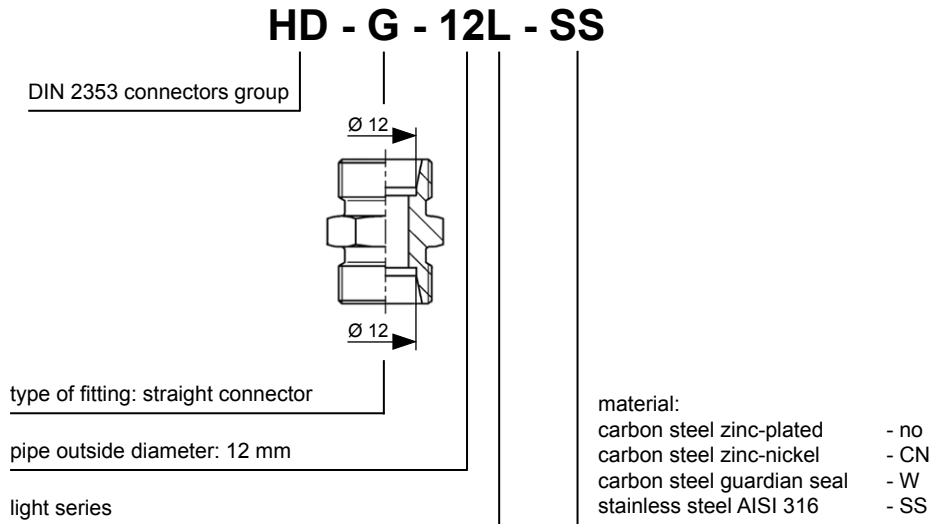

HIGH PRESSURE - DIN 2353 connectors

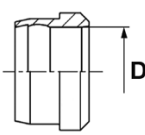
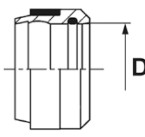
description	series	press. [bar]	code (galvanized steel)	code (AISI 316)	code (galvanized steel)	code (AISI 316)	D [mm]
<p>Cutting ring</p>  <p style="text-align: center;">D</p>  <p style="text-align: center;">DU</p>	LL	100	HD-D-04LL	HD-D-04LL-SS	-	-	4
			HD-D-06LL	HD-D-06LL-SS	-	-	6
			HD-D-08LL	HD-D-08LL-SS	-	-	8
	L	315	HD-D-06	HD-D-06-SS	HD-DU-06L	HD-DU-06L-SS	6
			HD-D-08	HD-D-08-SS	HD-DU-08L	HD-DU-08L-SS	8
			HD-D-10	HD-D-10-SS	HD-DU-10L	HD-DU-10L-SS	10
			HD-D-12	HD-D-12-SS	HD-DU-12L	HD-DU-12L-SS	12
			HD-D-15	HD-D-15-SS	HD-DU-15L	HD-DU-15L-SS	15
			HD-D-18	HD-D-18-SS	HD-DU-18L	HD-DU-18L-SS	18
			HD-D-22	HD-D-22-SS	HD-DU-22L	HD-DU-22L-SS	22
			HD-D-28	HD-D-28-SS	HD-DU-28L	HD-DU-28L-SS	28
			HD-D-35	HD-D-35-SS	HD-DU-35L	HD-DU-35L-SS	35
	S	630	HD-D-06	HD-D-06-SS	HD-DU-06S	HD-DU-06S-SS	6
			HD-D-08	HD-D-08-SS	HD-DU-08S	HD-DU-08S-SS	8
			HD-D-10	HD-D-10-SS	HD-DU-10S	HD-DU-10S-SS	10
		400	HD-D-12	HD-D-12-SS	HD-DU-12S	HD-DU-12S-SS	12
			HD-D-14	HD-D-14-SS	HD-DU-14S	HD-DU-14S-SS	14
			HD-D-16	HD-D-16-SS	HD-DU-16S	HD-DU-16S-SS	16
			HD-D-20	HD-D-20-SS	HD-DU-20S	HD-DU-20S-SS	20
			HD-D-25	HD-D-25-SS	HD-DU-25S	HD-DU-25S-SS	25
			HD-D-30	HD-D-30-SS	HD-DU-30S	HD-DU-30S-SS	30
	315	HD-D-38	HD-D-38-SS	HD-DU-38S	HD-DU-38S-SS	38	

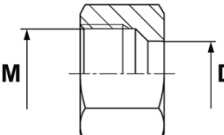
description	series	press. [bar]	code (galvanized steel)	code (AISI 316)	D [mm]	M [mm]
<p>Nut</p>  <p style="text-align: center;">M</p>	LL	100	HD-M-04LL	HD-M-04LL-SS	4	8x1
			HD-M-06LL	HD-M-06LL-SS	6	10x1
			HD-M-08LL	HD-M-08LL-SS	8	12x1
	L	315	HD-M-06L	HD-M-06L-SS	6	12x1.5
			HD-M-08L	HD-M-08L-SS	8	14x1.5
			HD-M-10L	HD-M-10L-SS	10	16x1.5
			HD-M-12L	HD-M-12L-SS	12	18x1.5
			HD-M-15L	HD-M-15L-SS	15	22x1.5
			HD-M-18L	HD-M-18L-SS	18	26x1.5
			HD-M-22L	HD-M-22L-SS	22	30x2
			HD-M-28L	HD-M-28L-SS	28	36x2
			HD-M-35L	HD-M-35L-SS	35	45x2
	S	630	HD-M-06S	HD-M-06S-SS	6	14x1.5
			HD-M-08S	HD-M-08S-SS	8	16x1.5
			HD-M-10S	HD-M-10S-SS	10	18x1.5
		400	HD-M-12S	HD-M-12S-SS	12	20x1.5
			HD-M-14S	HD-M-14S-SS	14	22x1.5
			HD-M-16S	HD-M-16S-SS	16	24x1.5
			HD-M-20S	HD-M-20S-SS	20	30x2
			HD-M-25S	HD-M-25S-SS	25	36x2
			HD-M-30S	HD-M-30S-SS	30	42x2
315	HD-M-38S	HD-M-38S-SS	38	52x2		

HIGH PRESSURE - DIN 2353 connectors

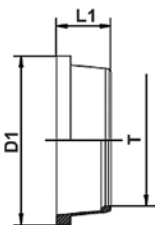
description	series	press. [bar]	code (FPM rubber)	T [mm]	D1 [mm]	L1 [mm]
Profiled seal, material: Viton 	L/S	630	HD-UDV-06LS	6	9	7.5
			HD-UDV-08LS	8	11	7.5
			HD-UDV-10LS	10	13.5	7.5
			HD-UDV-12LS	12	15.5	7
	L	400	HD-UDV-15L	15	19	7
			HD-UDV-18L	18	23	8
		250	HD-UDV-22L	22	26.5	8
			HD-UDV-28L	28	32.5	8
			HD-UDV-35L	35	41.5	8
			HD-UDV-42L	42	48.5	8
	S	630	HD-UDV-14S	14	19	7
			HD-UDV-16S	16	21	7.5
		420	HD-UDV-20S	20	26	9.5
			HD-UDV-25S	25	31.5	9
			HD-UDV-30S	30	37.5	8
	315	HD-UDV-38S	38	46	8	

UDV

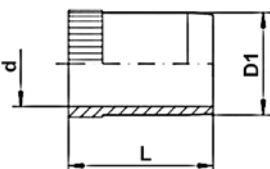
description	pipe I.D. [mm]	code (brass)	code (AISI 316)	d [mm]	D [mm]	L [mm]
Reinforcing insert for thin-walled pipes DIN 2353 	4	HD-VS-04	HD-VS-04-SS	2.5	3.8	17
	5	HD-VS-05	HD-VS-05-SS	3.5	4.8	17
	6	HD-VS-06	HD-VS-06-SS	4.5	5.8	17 / 14*
	7	-	HD-VS-07-SS	5.5	6.8	17
	8	HD-VS-08	HD-VS-08-SS	6.5	7.8	17 / 15.5*
	9	HD-VS-09	HD-VS-09-SS	7.5	8.8	17
	10	HD-VS-10	HD-VS-10-SS	8.5	9.8	17 / 15.5*
	11	-	HD-VS-11-SS	9.5	10.8	17
	12	HD-VS-12	HD-VS-12-SS	10.5	11.8	17
	13	HD-VS-13	HD-VS-13-SS	11.5	12.8	18 / 17*
	14	-	HD-VS-14-SS	12	13.8	17
	15	HD-VS-15	HD-VS-15-SS	13	14.8	18
	16	HD-VS-16	HD-VS-16-SS	14	15.8	18
	17	-	HD-VS-17-SS	15	16.8	20
	18	HD-VS-18	HD-VS-18-SS	16	17.8	22 / 20*
	19	HD-VS-19	HD-VS-19-SS	17	18.8	20
	20	-	HD-VS-20-SS	18	19.8	20
	22	-	HD-VS-22-SS	20	21.8	24
	23	-	HD-VS-23-SS	21	22.8	24
	24	HD-VS-24	HD-VS-24-SS	22	23.8	20 / 23.5*
	25	HD-VS-25	HD-VS-25-SS	23	24.8	20 / 23.5*
	26	-	HD-VS-26-SS	24	25.8	23.5
	30	-	HD-VS-30-SS	27.8	29.8	26.5
	31	HD-VS-31	HD-VS-31-SS	28	30.8	23 / 26.5*
	32	-	HD-VS-32-SS	29.5	31.8	26.5
	33	-	HD-VS-33-SS	30	32.8	26.5
	38	HD-VS-38	HD-VS-38-SS	35	37.8	24 / 26.5*

VS

*- L length is different for stainless steel

HIGH PRESSURE - DIN 2353 connectors

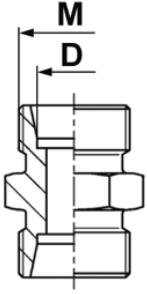
description	series	press. [bar]	code (galvanized steel)	code (AISI 316)	D [mm]	M [mm]	
Straight connector 	LL	100	HD-G-04LL	HD-G-04LL-SS	4	8x1	
			HD-G-06LL	HD-G-06LL-SS	6	10x1	
			HD-G-08LL	HD-G-08LL-SS	8	12x1	
	L	315	HD-G-06L	HD-G-06L-SS	6	12x1.5	
			HD-G-08L	HD-G-08L-SS	8	14x1.5	
			HD-G-10L	HD-G-10L-SS	10	16x1.5	
			HD-G-12L	HD-G-12L-SS	12	18x1.5	
			HD-G-15L	HD-G-15L-SS	15	22x1.5	
			HD-G-18L	HD-G-18L-SS	18	26x1.5	
			160	HD-G-22L	HD-G-22L-SS	22	30x2
				HD-G-28L	HD-G-28L-SS	28	36x2
				HD-G-35L	HD-G-35L-SS	35	45x2
	S	630	HD-G-06S	HD-G-06S-SS	6	14x1.5	
			HD-G-08S	HD-G-08S-SS	8	16x1.5	
			HD-G-10S	HD-G-10S-SS	10	18x1.5	
			HD-G-12S	HD-G-12S-SS	12	20x1.5	
			HD-G-14S	HD-G-14S-SS	14	22x1.5	
			HD-G-16S	HD-G-16S-SS	16	24x1.5	
		400	HD-G-20S	HD-G-20S-SS	20	30x2	
			HD-G-25S	HD-G-25S-SS	25	36x2	
			HD-G-30S	HD-G-30S-SS	30	42x2	
			315	HD-G-38S	HD-G-38S-SS	38	52x2

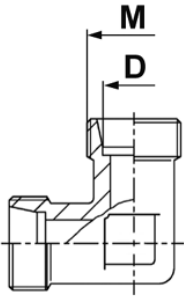
description	series	press. [bar]	code (galvanized steel)	code (AISI 316)	D [mm]	M [mm]	
90° elbow connector 	LL	100	HD-W-04LL	HD-W-04LL-SS	4	8x1	
			HD-W-06LL	HD-W-06LL-SS	6	10x1	
			HD-W-08LL	HD-W-08LL-SS	8	12x1	
	L	315	HD-W-06L	HD-W-06L-SS	6	12x1.5	
			HD-W-08L	HD-W-08L-SS	8	14x1.5	
			HD-W-10L	HD-W-10L-SS	10	16x1.5	
			HD-W-12L	HD-W-12L-SS	12	18x1.5	
			HD-W-15L	HD-W-15L-SS	15	22x1.5	
			HD-W-18L	HD-W-18L-SS	18	26x1.5	
			160	HD-W-22L	HD-W-22L-SS	22	30x2
				HD-W-28L	HD-W-28L-SS	28	36x2
				HD-W-35L	HD-W-35L-SS	35	45x2
	S	630	HD-W-06S	HD-W-06S-SS	6	14x1.5	
			HD-W-08S	HD-W-08S-SS	8	16x1.5	
			HD-W-10S	HD-W-10S-SS	10	18x1.5	
			HD-W-12S	HD-W-12S-SS	12	20x1.5	
			HD-W-14S	HD-W-14S-SS	14	22x1.5	
			HD-W-16S	HD-W-16S-SS	16	24x1.5	
		400	HD-W-20S	HD-W-20S-SS	20	30x2	
			HD-W-25S	HD-W-25S-SS	25	36x2	
			HD-W-30S	HD-W-30S-SS	30	42x2	
			315	HD-W-38S	HD-W-38S-SS	38	52x2

HIGH PRESSURE - DIN 2353 connectors

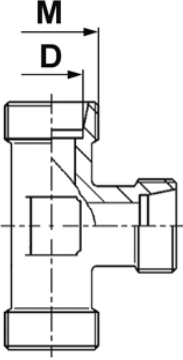
description	series	press. [bar]	code (galvanized steel)	code (AISI 316)	D [mm]	M [mm]
Tee connector  T	L	315	HD-T-06L	HD-T-06L-SS	6	12x1.5
			HD-T-08L	HD-T-08L-SS	8	14x1.5
			HD-T-10L	HD-T-10L-SS	10	16x1.5
			HD-T-12L	HD-T-12L-SS	12	18x1.5
			HD-T-15L	HD-T-15L-SS	15	22x1.5
		HD-T-18L	HD-T-18L-SS	18	26x1.5	
		160	HD-T-22L	HD-T-22L-SS	22	30x2
			HD-T-28L	HD-T-28L-SS	28	36x2
			HD-T-35L	HD-T-35L-SS	35	45x2
			HD-T-42L	HD-T-42L-SS	42	52x2
	S		630	HD-T-06S	HD-T-06S-SS	6
		HD-T-08S		HD-T-08S-SS	8	16x1.5
		HD-T-10S		HD-T-10S-SS	10	18x1.5
		HD-T-12S		HD-T-12S-SS	12	20x1.5
		HD-T-14S		HD-T-14S-SS	14	22x1.5
		400	HD-T-16S	HD-T-16S-SS	16	24x1.5
			HD-T-20S	HD-T-20S-SS	20	30x2
			HD-T-25S	HD-T-25S-SS	25	36x2
			HD-T-30S	HD-T-30S-SS	30	42x2
			315	HD-T-38S	HD-T-38S-SS	38

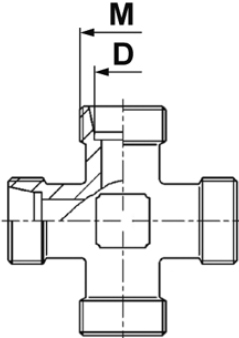
description	series	press. [bar]	code (galvanized steel)	code (AISI 316)	D [mm]	M [mm]
Cross connector  K	L	315	HD-K-06L	HD-K-06L-SS	6	12x1.5
			HD-K-08L	HD-K-08L-SS	8	14x1.5
			HD-K-10L	HD-K-10L-SS	10	16x1.5
			HD-K-12L	HD-K-12L-SS	12	18x1.5
			HD-K-15L	HD-K-15L-SS	15	22x1.5
		HD-K-18L	HD-K-18L-SS	18	26x1.5	
		160	HD-K-22L	HD-K-22L-SS	22	30x2
			HD-K-28L	HD-K-28L-SS	28	36x2
			HD-K-35L	HD-K-35L-SS	35	45x2
			HD-K-42L	HD-K-42L-SS	42	52x2
	S		630	HD-K-06S	HD-K-06S-SS	6
		HD-K-08S		HD-K-08S-SS	8	16x1.5
		HD-K-10S		HD-K-10S-SS	10	18x1.5
		HD-K-12S		HD-K-12S-SS	12	20x1.5
		HD-K-14S		HD-K-14S-SS	14	22x1.5
		400	HD-K-16S	HD-K-16S-SS	16	24x1.5
			HD-K-20S	HD-K-20S-SS	20	30x2
			HD-K-25S	HD-K-25S-SS	25	36x2
			HD-K-30S	HD-K-30S-SS	30	42x2
			315	HD-K-38S	HD-K-38S-SS	38

HIGH PRESSURE - DIN 2353 connectors

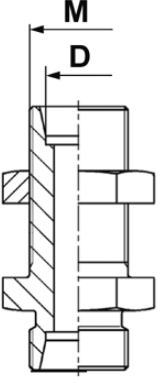
description	series	press. [bar]	code (galvanized steel)	code (AISI 316)	D [mm]	M [mm]
Straight bulkhead connector 	L	315	HD-SV-06L	HD-SV-06L-SS	6	12x1.5
			HD-SV-08L	HD-SV-08L-SS	8	14x1.5
			HD-SV-10L	HD-SV-10L-SS	10	16x1.5
			HD-SV-12L	HD-SV-12L-SS	12	18x1.5
			HD-SV-15L	HD-SV-15L-SS	15	22x1.5
		HD-SV-18L	HD-SV-18L-SS	18	26x1.5	
		160	HD-SV-22L	HD-SV-22L-SS	22	30x2
			HD-SV-28L	HD-SV-28L-SS	28	36x2
			HD-SV-35L	HD-SV-35L-SS	35	45x2
			HD-SV-42L	HD-SV-42L-SS	42	52x2
	S		630	HD-SV-06S	HD-SV-06S-SS	6
		HD-SV-08S		HD-SV-08S-SS	8	16x1.5
		HD-SV-10S		HD-SV-10S-SS	10	18x1.5
		HD-SV-12S		HD-SV-12S-SS	12	20x1.5
		HD-SV-14S		HD-SV-14S-SS	14	22x1.5
		400	HD-SV-16S	HD-SV-16S-SS	16	24x1.5
			HD-SV-20S	HD-SV-20S-SS	20	30x2
			HD-SV-25S	HD-SV-25S-SS	25	36x2
			HD-SV-30S	HD-SV-30S-SS	30	42x2
			315	HD-SV-38S	HD-SV-38S-SS	38

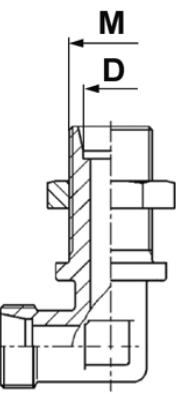
description	series	press. [bar]	code (galvanized steel)	code (AISI 316)	D [mm]	M [mm]
90° elbow bulkhead connector 	L	315	HD-WSV-06L	HD-WSV-06L-SS	6	12x1.5
			HD-WSV-08L	HD-WSV-08L-SS	8	14x1.5
			HD-WSV-10L	HD-WSV-10L-SS	10	16x1.5
			HD-WSV-12L	HD-WSV-12L-SS	12	18x1.5
			HD-WSV-15L	HD-WSV-15L-SS	15	22x1.5
		HD-WSV-18L	HD-WSV-18L-SS	18	26x1.5	
		160	HD-WSV-22L	HD-WSV-22L-SS	22	30x2
			HD-WSV-28L	HD-WSV-28L-SS	28	36x2
			HD-WSV-35L	HD-WSV-35L-SS	35	45x2
			HD-WSV-42L	HD-WSV-42L-SS	42	52x2
	S		630	HD-WSV-06S	HD-WSV-06S-SS	6
		HD-WSV-08S		HD-WSV-08S-SS	8	16x1.5
		HD-WSV-10S		HD-WSV-10S-SS	10	18x1.5
		HD-WSV-12S		HD-WSV-12S-SS	12	20x1.5
		HD-WSV-14S		HD-WSV-14S-SS	14	22x1.5
		400	HD-WSV-16S	HD-WSV-16S-SS	16	24x1.5
			HD-WSV-20S	HD-WSV-20S-SS	20	30x2
			HD-WSV-25S	HD-WSV-25S-SS	25	36x2
			HD-WSV-30S	HD-WSV-30S-SS	30	42x2
			315	HD-WSV-38S	HD-WSV-38S-SS	38

HIGH PRESSURE - DIN 2353 connectors

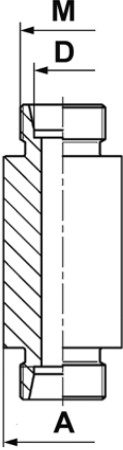
description	series	press. [bar]	code (black steel)	code (AISI 316)	D [mm]	M [mm]	A [mm]
Welding bulkhead connector 	L	315	HD-ESV-06L	HD-ESV-06L-SS	6	12x1.5	18
			HD-ESV-08L	HD-ESV-08L-SS	8	14x1.5	20
			HD-ESV-10L	HD-ESV-10L-SS	10	16x1.5	22
			HD-ESV-12L	HD-ESV-12L-SS	12	18x1.5	25
			HD-ESV-15L	HD-ESV-15L-SS	15	22x1.5	28
		HD-ESV-18L	HD-ESV-18L-SS	18	26x1.5	32	
		160	HD-ESV-22L	HD-ESV-22L-SS	22	30x2	36
			HD-ESV-28L	HD-ESV-28L-SS	28	36x2	40
			HD-ESV-35L	HD-ESV-35L-SS	35	45x2	50
			HD-ESV-42L	HD-ESV-42L-SS	42	52x2	60
	S		630	HD-ESV-06S	HD-ESV-06S-SS	6	14x1.5
		HD-ESV-08S		HD-ESV-08S-SS	8	16x1.5	22
		HD-ESV-10S		HD-ESV-10S-SS	10	18x1.5	25
		HD-ESV-12S		HD-ESV-12S-SS	12	20x1.5	28
		HD-ESV-14S		HD-ESV-14S-SS	14	22x1.5	30
		400	HD-ESV-16S	HD-ESV-16S-SS	16	24x1.5	35
			HD-ESV-20S	HD-ESV-20S-SS	20	30x2	38
			HD-ESV-25S	HD-ESV-25S-SS	25	36x2	45
			HD-ESV-30S	HD-ESV-30S-SS	30	42x2	50
			315	HD-ESV-38S	HD-ESV-38S-SS	38	52x2

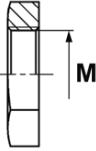
description	code (galvanized steel)	code (AISI 316)	M [mm]
Flat nut for bulkhead connectors 	HD-MP-06L	HD-MP-06L-SS	12x1.5
	HD-MP-08L-06S	HD-MP-08L-06S-SS	14x1.5
	HD-MP-10L-08S	HD-MP-10L-08S-SS	16x1.5
	HD-MP-12L-10S	HD-MP-12L-10S-SS	18x1.5
	HD-MP-12S	HD-MP-12S-SS	20x1.5
	HD-MP-15L-14S	HD-MP-15L-14S-SS	22x1.5
	HD-MP-16S	HD-MP-16S-SS	24x1.5
	HD-MP-18L	HD-MP-18L-SS	26x1.5
	HD-MP-22L-20S	HD-MP-22L-20S-SS	30x2
	HD-MP-28L-25S	HD-MP-28L-25S-SS	36x2
	HD-MP-30S	HD-MP-30S-SS	42x2
	HD-MP-35L	HD-MP-35L-SS	48x2
	HD-MP-42L-38S	HD-MP-42L-38S-SS	52x2

HIGH PRESSURE - DIN 2353 connectors

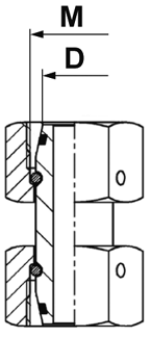
description	series	press. [bar]	code (galvanized steel)	code (AISI 316)	D [mm]	M [mm]
Adjustable straight connector, O-ring seal  SNV	L	315	HD-SNV-06L	HD-SNV-06L-SS	6	12x1.5
			HD-SNV-08L	HD-SNV-08L-SS	8	14x1.5
			HD-SNV-10L	HD-SNV-10L-SS	10	16x1.5
			HD-SNV-12L	HD-SNV-12L-SS	12	18x1.5
			HD-SNV-15L	HD-SNV-15L-SS	15	22x1.5
			HD-SNV-18L	HD-SNV-18L-SS	18	26x1.5
		160	HD-SNV-22L	HD-SNV-22L-SS	22	30x2
			HD-SNV-28L	HD-SNV-28L-SS	28	36x2
			HD-SNV-35L	HD-SNV-35L-SS	35	45x2
			HD-SNV-42L	HD-SNV-42L-SS	42	52x2
	S	630	HD-SNV-06S	HD-SNV-06S-SS	6	14x1.5
			HD-SNV-08S	HD-SNV-08S-SS	8	16x1.5
			HD-SNV-10S	HD-SNV-10S-SS	10	18x1.5
			HD-SNV-12S	HD-SNV-12S-SS	12	20x1.5
			HD-SNV-14S	HD-SNV-14S-SS	14	22x1.5
		400	HD-SNV-16S	HD-SNV-16S-SS	16	24x1.5
			HD-SNV-20S	HD-SNV-20S-SS	20	30x2
			HD-SNV-25S	HD-SNV-25S-SS	25	36x2
			HD-SNV-30S	HD-SNV-30S-SS	30	42x2
			315	HD-SNV-38S	HD-SNV-38S-SS	38

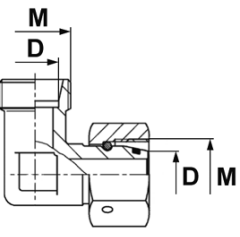
description	series	press. [bar]	code (galvanized steel)	code (AISI 316)	D [mm]	M [mm]
Adjustable 90° elbow connector, O-ring seal  EVWO	L	315	HD-EVWO-06L	HD-EVWO-06L-SS	6	12x1.5
			HD-EVWO-08L	HD-EVWO-08L-SS	8	14x1.5
			HD-EVWO-10L	HD-EVWO-10L-SS	10	16x1.5
			HD-EVWO-12L	HD-EVWO-12L-SS	12	18x1.5
			HD-EVWO-15L	HD-EVWO-15L-SS	15	22x1.5
			HD-EVWO-18L	HD-EVWO-18L-SS	18	26x1.5
		160	HD-EVWO-22L	HD-EVWO-22L-SS	22	30x2
			HD-EVWO-28L	HD-EVWO-28L-SS	28	36x2
			HD-EVWO-35L	HD-EVWO-35L-SS	35	45x2
			HD-EVWO-42L	HD-EVWO-42L-SS	42	52x2
	S	630	HD-EVWO-06S	HD-EVWO-06S-SS	6	14x1.5
			HD-EVWO-08S	HD-EVWO-08S-SS	8	16x1.5
			HD-EVWO-10S	HD-EVWO-10S-SS	10	18x1.5
			HD-EVWO-12S	HD-EVWO-12S-SS	12	20x1.5
			HD-EVWO-14S	HD-EVWO-14S-SS	14	22x1.5
		400	HD-EVWO-16S	HD-EVWO-16S-SS	16	24x1.5
			HD-EVWO-20S	HD-EVWO-20S-SS	20	30x2
			HD-EVWO-25S	HD-EVWO-25S-SS	25	36x2
			HD-EVWO-30S	HD-EVWO-30S-SS	30	42x2
			315	HD-EVWO-38S	HD-EVWO-38S-SS	38

HIGH PRESSURE - DIN 2353 connectors

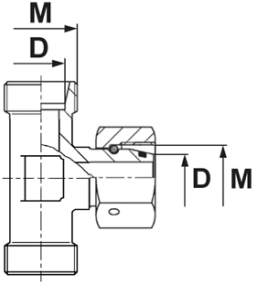
description	series	press. [bar]	code (galvanized steel)	code (AISI 316)	D [mm]	M [mm]
Adjustable tee connector, O-ring seal  EVTO	L	315	HD-EVTO-06L	HD-EVTO-06L-SS	6	12x1.5
			HD-EVTO-08L	HD-EVTO-08L-SS	8	14x1.5
			HD-EVTO-10L	HD-EVTO-10L-SS	10	16x1.5
			HD-EVTO-12L	HD-EVTO-12L-SS	12	18x1.5
			HD-EVTO-15L	HD-EVTO-15L-SS	15	22x1.5
			HD-EVTO-18L	HD-EVTO-18L-SS	18	26x1.5
		160	HD-EVTO-22L	HD-EVTO-22L-SS	22	30x2
			HD-EVTO-28L	HD-EVTO-28L-SS	28	36x2
			HD-EVTO-35L	HD-EVTO-35L-SS	35	45x2
			HD-EVTO-42L	HD-EVTO-42L-SS	42	52x2
	S	630	HD-EVTO-06S	HD-EVTO-06S-SS	6	14x1.5
			HD-EVTO-08S	HD-EVTO-08S-SS	8	16x1.5
			HD-EVTO-10S	HD-EVTO-10S-SS	10	18x1.5
			HD-EVTO-12S	HD-EVTO-12S-SS	12	20x1.5
			HD-EVTO-14S	HD-EVTO-14S-SS	14	22x1.5
			HD-EVTO-16S	HD-EVTO-16S-SS	16	24x1.5
		400	HD-EVTO-20S	HD-EVTO-20S-SS	20	30x2
			HD-EVTO-25S	HD-EVTO-25S-SS	25	36x2
			HD-EVTO-30S	HD-EVTO-30S-SS	30	42x2
			HD-EVTO-38S	HD-EVTO-38S-SS	38	52x2

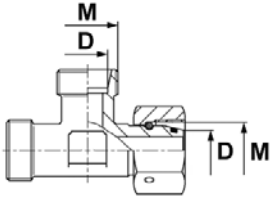
description	series	press. [bar]	code (galvanized steel)	code (AISI 316)	D [mm]	M [mm]
Asymmetric adjustable tee connector, O-ring seal  EVLO	L	315	HD-EVLO-06L	HD-EVLO-06L-SS	6	12x1.5
			HD-EVLO-08L	HD-EVLO-08L-SS	8	14x1.5
			HD-EVLO-10L	HD-EVLO-10L-SS	10	16x1.5
			HD-EVLO-12L	HD-EVLO-12L-SS	12	18x1.5
			HD-EVLO-15L	HD-EVLO-15L-SS	15	22x1.5
			HD-EVLO-18L	HD-EVLO-18L-SS	18	26x1.5
		160	HD-EVLO-22L	HD-EVLO-22L-SS	22	30x2
			HD-EVLO-28L	HD-EVLO-28L-SS	28	36x2
			HD-EVLO-35L	HD-EVLO-35L-SS	35	45x2
			HD-EVLO-42L	HD-EVLO-42L-SS	42	52x2
	S	630	HD-EVLO-06S	HD-EVLO-06S-SS	6	14x1.5
			HD-EVLO-08S	HD-EVLO-08S-SS	8	16x1.5
			HD-EVLO-10S	HD-EVLO-10S-SS	10	18x1.5
			HD-EVLO-12S	HD-EVLO-12S-SS	12	20x1.5
			HD-EVLO-14S	HD-EVLO-14S-SS	14	22x1.5
			HD-EVLO-16S	HD-EVLO-16S-SS	16	24x1.5
		400	HD-EVLO-20S	HD-EVLO-20S-SS	20	30x2
			HD-EVLO-25S	HD-EVLO-25S-SS	25	36x2
			HD-EVLO-30S	HD-EVLO-30S-SS	30	42x2
			HD-EVLO-38S	HD-EVLO-38S-SS	38	52x2

HIGH PRESSURE - DIN 2353 connectors

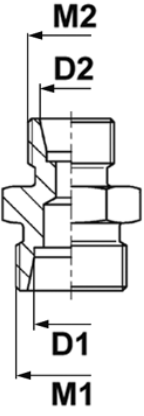
description	series	press. [bar]	code (galvanized steel)	code (AISI 316)	D1 [mm]	M1 [mm]	D2 [mm]	M2 [mm]
 <p style="text-align: center;">GR</p>	L	315	HD-GR-08-06L	HD-GR-08-06L-SS	8	14x1.5	6	12x1.5
			HD-GR-10-06L	HD-GR-10-06L-SS	10	16x1.5	6	12x1.5
			HD-GR-10-08L	HD-GR-10-08L-SS	10	16x1.5	8	14x1.5
			HD-GR-12-06L	HD-GR-12-06L-SS	12	18x1.5	6	12x1.5
			HD-GR-12-08L	HD-GR-12-08L-SS	12	18x1.5	8	14x1.5
			HD-GR-12-10L	HD-GR-12-10L-SS	12	18x1.5	10	16x1.5
			HD-GR-15-10L	HD-GR-15-10L-SS	15	22x1.5	10	16x1.5
			HD-GR-15-12L	HD-GR-15-12L-SS	15	22x1.5	12	18x1.5
			HD-GR-18-10L	HD-GR-18-10L-SS	18	26x1.5	10	16x1.5
		HD-GR-18-12L	HD-GR-18-12L-SS	18	26x1.5	12	18x1.5	
		HD-GR-18-15L	HD-GR-18-15L-SS	18	26x1.5	15	22x1.5	
		160	HD-GR-22-12L	HD-GR-22-12L-SS	22	30x2	12	18x1.5
			HD-GR-22-15L	HD-GR-22-15L-SS	22	30x2	15	22x1.5
			HD-GR-22-18L	HD-GR-22-18L-SS	22	30x2	18	26x1.5
			HD-GR-28-18L	HD-GR-28-18L-SS	28	36x2	18	26x1.5
			HD-GR-28-22L	HD-GR-28-22L-SS	28	36x2	22	30x2
			HD-GR-35-22L	HD-GR-35-22L-SS	35	45x2	22	30x2
		S	630	HD-GR-35-28L	HD-GR-35-28L-SS	35	45x2	28
	HD-GR-08-06S			HD-GR-08-06S-SS	8	16x1.5	6	14x1.5
	HD-GR-10-06S			HD-GR-10-06S-SS	10	18x1.5	6	14x1.5
	HD-GR-10-08S			HD-GR-10-08S-SS	10	18x1.5	8	16x1.5
	HD-GR-12-06S			HD-GR-12-06S-SS	12	20x1.5	6	14x1.5
	HD-GR-12-08S			HD-GR-12-08S-SS	12	20x1.5	8	16x1.5
	400		HD-GR-12-10S	HD-GR-12-10S-SS	12	20x1.5	10	18x1.5
			HD-GR-14-10S	HD-GR-14-10S-SS	14	22x1.5	10	18x1.5
			HD-GR-14-12S	HD-GR-14-12S-SS	14	22x1.5	12	20x1.5
			HD-GR-16-12S	HD-GR-16-12S-SS	16	24x1.5	12	20x1.5
			HD-GR-16-14S	HD-GR-16-14S-SS	16	24x1.5	14	22x1.5
			HD-GR-20-10S	HD-GR-20-10S-SS	20	30x2	10	18x1.5
	315	HD-GR-20-12S	HD-GR-20-12S-SS	20	30x2	12	20x1.5	
		HD-GR-20-16S	HD-GR-20-16S-SS	20	30x2	16	24x1.5	
		HD-GR-25-16S	HD-GR-25-16S-SS	25	36x2	16	24x1.5	
		HD-GR-25-20S	HD-GR-25-20S-SS	25	36x2	20	30x2	
		HD-GR-30-20S	HD-GR-30-20S-SS	30	42x2	20	30x2	
	HD-GR-30-25S	HD-GR-30-25S-SS	30	42x2	25	36x2		
HD-GR-38-30S	HD-GR-38-30S-SS	38	52x2	38	42x2			

HIGH PRESSURE - DIN 2353 connectors

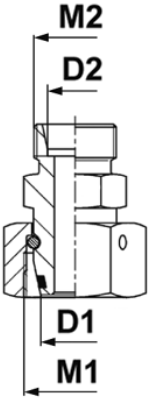
description	series	press. [bar]	code (galvanized steel)	code (AISI 316)	D1 [mm]	M1 [mm]	D2 [mm]	M2 [mm]
<div style="text-align: center;">  </div> <p style="text-align: center;">KORO-L</p>	L	315	HD-KORO-08-06L	HD-KORO-08-06L-SS	8	14x1.5	6	12x1.5
			HD-KORO-10-06L	HD-KORO-10-06L-SS	10	16x1.5	6	12x1.5
			HD-KORO-12-06L	HD-KORO-12-06L-SS	12	18x1.5	6	12x1.5
			HD-KORO-15-06L	HD-KORO-15-06L-SS	15	22x1.5	6	12x1.5
			HD-KORO-18-06L	HD-KORO-18-06L-SS	18	26x1.5	6	12x1.5
		160	HD-KORO-22-06L	HD-KORO-22-06L-SS	22	30x2	6	12x1.5
			HD-KORO-28-06L	HD-KORO-28-06L-SS	28	36x2	6	12x1.5
			HD-KORO-35-06L	HD-KORO-35-06L-SS	35	45x2	6	12x1.5
			HD-KORO-42-06L	HD-KORO-42-06L-SS	42	52x2	6	12x1.5
		315	HD-KORO-10-08L	HD-KORO-10-08L-SS	10	16x1.5	8	14x1.5
			HD-KORO-12-08L	HD-KORO-12-08L-SS	12	18x1.5	8	14x1.5
			HD-KORO-15-08L	HD-KORO-15-08L-SS	15	22x1.5	8	14x1.5
		160	HD-KORO-18-08L	HD-KORO-18-08L-SS	18	26x1.5	8	14x1.5
			HD-KORO-22-08L	HD-KORO-22-08L-SS	22	30x2	8	14x1.5
			HD-KORO-28-08L	HD-KORO-28-08L-SS	28	36x2	8	14x1.5
			HD-KORO-35-08L	HD-KORO-35-08L-SS	35	45x2	8	14x1.5
		315	HD-KORO-42-08L	HD-KORO-42-08L-SS	42	52x2	8	14x1.5
			HD-KORO-12-10L	HD-KORO-12-10L-SS	12	18x1.5	10	16x1.5
			HD-KORO-15-10L	HD-KORO-15-10L-SS	15	22x1.5	10	16x1.5
		160	HD-KORO-18-10L	HD-KORO-18-10L-SS	18	26x1.5	10	16x1.5
			HD-KORO-22-10L	HD-KORO-22-10L-SS	22	30x2	10	16x1.5
			HD-KORO-28-10L	HD-KORO-28-10L-SS	28	36x2	10	16x1.5
			HD-KORO-35-10L	HD-KORO-35-10L-SS	35	45x2	10	16x1.5
		315	HD-KORO-42-10L	HD-KORO-42-10L-SS	42	52x2	10	16x1.5
			HD-KORO-15-12L	HD-KORO-15-12L-SS	15	22x1.5	12	18x1.5
			HD-KORO-18-12L	HD-KORO-18-12L-SS	18	26x1.5	12	18x1.5
		160	HD-KORO-22-12L	HD-KORO-22-12L-SS	22	30x2	12	18x1.5
			HD-KORO-28-12L	HD-KORO-28-12L-SS	28	36x2	12	18x1.5
			HD-KORO-35-12L	HD-KORO-35-12L-SS	35	45x2	12	18x1.5
			HD-KORO-42-12L	HD-KORO-42-12L-SS	42	52x2	12	18x1.5
		315	HD-KORO-18-15L	HD-KORO-18-15L-SS	18	26x1.5	15	22x1.5
		160	HD-KORO-22-15L	HD-KORO-22-15L-SS	22	30x2	15	22x1.5
			HD-KORO-28-15L	HD-KORO-28-15L-SS	28	36x2	15	22x1.5
			HD-KORO-35-15L	HD-KORO-35-15L-SS	35	45x2	15	22x1.5
			HD-KORO-42-15L	HD-KORO-42-15L-SS	42	52x2	15	22x1.5
			HD-KORO-22-18L	HD-KORO-22-18L-SS	22	30x2	18	26x1.5
			HD-KORO-28-18L	HD-KORO-28-18L-SS	28	36x2	18	26x1.5
			HD-KORO-35-18L	HD-KORO-35-18L-SS	35	45x2	18	26x1.5
			HD-KORO-42-18L	HD-KORO-42-18L-SS	42	52x2	18	26x1.5
			HD-KORO-28-22L	HD-KORO-28-22L-SS	28	36x2	22	30x2
			HD-KORO-35-22L	HD-KORO-35-22L-SS	35	45x2	22	30x2
			HD-KORO-42-22L	HD-KORO-42-22L-SS	42	52x2	22	30x2
			HD-KORO-35-28L	HD-KORO-35-28L-SS	35	45x2	28	36x2
			HD-KORO-42-28L	HD-KORO-42-28L-SS	42	52x2	28	36x2
		HD-KORO-42-35L	HD-KORO-42-35L-SS	42	52x2	35	45x2	

HIGH PRESSURE - DIN 2353 connectors

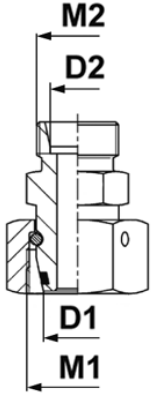
description	series	press. [bar]	code (galvanized steel)	code (AISI 316)	D1 [mm]	M1 [mm]	D2 [mm]	M2 [mm]
Reducing connector 	S	630	HD-KORO-08-06S	HD-KORO-08-06S-SS	8	16x1.5	6	14x1.5
			HD-KORO-10-06S	HD-KORO-10-06S-SS	10	18x1.5	6	14x1.5
			HD-KORO-12-06S	HD-KORO-12-06S-SS	12	20x1.5	6	14x1.5
			HD-KORO-14-06S	HD-KORO-14-06S-SS	14	22x1.5	6	14x1.5
		400	HD-KORO-16-06S	HD-KORO-16-06S-SS	16	24x1.5	6	14x1.5
			HD-KORO-20-06S	HD-KORO-20-06S-SS	20	30x2	6	14x1.5
			HD-KORO-25-06S	HD-KORO-25-06S-SS	25	36x2	6	14x1.5
		315	HD-KORO-30-06S	HD-KORO-30-06S-SS	30	42x2	6	14x1.5
			HD-KORO-38-06S	HD-KORO-38-06S-SS	38	52x2	6	14x1.5
		630	HD-KORO-10-08S	HD-KORO-10-08S-SS	10	18x1.5	8	16x1.5
			HD-KORO-12-08S	HD-KORO-12-08S-SS	12	20x1.5	8	16x1.5
			HD-KORO-14-08S	HD-KORO-14-08S-SS	14	22x1.5	8	16x1.5
		400	HD-KORO-16-08S	HD-KORO-16-08S-SS	16	24x1.5	8	16x1.5
			HD-KORO-20-08S	HD-KORO-20-08S-SS	20	30x2	8	16x1.5
			HD-KORO-25-08S	HD-KORO-25-08S-SS	25	36x2	8	16x1.5
		315	HD-KORO-30-08S	HD-KORO-30-08S-SS	30	42x2	8	16x1.5
			HD-KORO-38-08S	HD-KORO-38-08S-SS	38	52x2	8	16x1.5
		630	HD-KORO-12-10S	HD-KORO-12-10S-SS	12	20x1.5	10	18x1.5
			HD-KORO-14-10S	HD-KORO-14-10S-SS	14	22x1.5	10	18x1.5
		400	HD-KORO-16-10S	HD-KORO-16-10S-SS	16	24x1.5	10	18x1.5
			HD-KORO-20-10S	HD-KORO-20-10S-SS	20	30x2	10	18x1.5
			HD-KORO-25-10S	HD-KORO-25-10S-SS	25	36x2	10	18x1.5
		250	HD-KORO-30-10S	HD-KORO-30-10S-SS	30	42x2	10	18x1.5
			HD-KORO-38-10S	HD-KORO-38-10S-SS	38	52x2	10	18x1.5
		630	HD-KORO-14-12S	HD-KORO-14-12S-SS	14	22x1.5	12	20x1.5
			HD-KORO-16-12S	HD-KORO-16-12S-SS	16	24x1.5	12	20x1.5
			HD-KORO-20-12S	HD-KORO-20-12S-SS	20	30x2	12	20x1.5
			HD-KORO-25-12S	HD-KORO-25-12S-SS	25	36x2	12	20x1.5
		400	HD-KORO-30-12S	HD-KORO-30-12S-SS	30	42x2	12	20x1.5
			HD-KORO-38-12S	HD-KORO-38-12S-SS	38	52x2	12	20x1.5
			HD-KORO-16-14S	HD-KORO-16-14S-SS	16	24x1.5	14	22x1.5
			HD-KORO-20-14S	HD-KORO-20-14S-SS	20	30x2	14	22x1.5
		250	HD-KORO-25-14S	HD-KORO-25-14S-SS	25	36x2	14	22x1.5
			HD-KORO-30-14S	HD-KORO-30-14S-SS	30	42x2	14	22x1.5
			HD-KORO-38-14S	HD-KORO-38-14S-SS	38	52x2	14	22x1.5
		400	HD-KORO-20-16S	HD-KORO-20-16S-SS	20	30x2	16	24x1.5
			HD-KORO-25-16S	HD-KORO-25-16S-SS	25	36x2	16	24x1.5
			HD-KORO-30-16S	HD-KORO-30-16S-SS	30	42x2	16	24x1.5
		315	HD-KORO-38-16S	HD-KORO-38-16S-SS	38	52x2	16	24x1.5
			HD-KORO-25-20S	HD-KORO-25-20S-SS	25	36x2	20	30x2
		400	HD-KORO-30-20S	HD-KORO-30-20S-SS	30	42x2	20	30x2
			HD-KORO-38-20S	HD-KORO-38-20S-SS	38	52x2	20	30x2
			HD-KORO-30-25S	HD-KORO-30-25S-SS	30	42x2	25	36x2
		315	HD-KORO-38-25S	HD-KORO-38-25S-SS	38	52x2	25	36x2
HD-KORO-38-30S	HD-KORO-38-30S-SS		38	52x2	30	42x2		

KORO-S

HIGH PRESSURE - DIN 2353 connectors

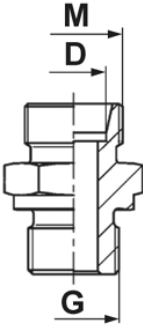
description	series	press. [bar]	code (galvanized steel)	code (AISI 316)	D [mm]	M [mm]	G [BSP]		
Connector with BSP thread, DIN 3852-B seal 	L	315	HD-GE-06L-BB-02	HD-GE-06L-BB-02-SS	6	12x1.5	1/8		
			HD-GE-08L-BB-04	HD-GE-08L-BB-04-SS	8	14x1.5	1/4		
			HD-GE-10L-BB-04	HD-GE-10L-BB-04-SS	10	16x1.5	1/4		
			HD-GE-12L-BB-06	HD-GE-12L-BB-06-SS	12	18x1.5	3/8		
			HD-GE-15L-BB-08	HD-GE-15L-BB-08-SS	15	22x1.5	1/2		
			HD-GE-18L-BB-08	HD-GE-18L-BB-08-SS	18	26x1.5	1/2		
		160	HD-GE-22L-BB-12	HD-GE-22L-BB-12-SS	22	30x2	3/4		
			HD-GE-28L-BB-16	HD-GE-28L-BB-16-SS	28	36x2	1		
			HD-GE-35L-BB-20	HD-GE-35L-BB-20-SS	35	45x2	1.1/4		
			HD-GE-42L-BB-24	HD-GE-42L-BB-24-SS	42	52x2	1.1/2		
			S	630	HD-GE-06S-BB-04	HD-GE-06S-BB-04-SS	6	14x1.5	1/4
					HD-GE-08S-BB-04	HD-GE-08S-BB-04-SS	8	16x1.5	1/4
	HD-GE-10S-BB-06	HD-GE-10S-BB-06-SS			10	18x1.5	3/8		
	HD-GE-12S-BB-06	HD-GE-12S-BB-06-SS			12	20x1.5	3/8		
	HD-GE-14S-BB-08	HD-GE-14S-BB-08-SS			14	22x1.5	1/2		
	400	HD-GE-16S-BB-08			HD-GE-16S-BB-08-SS	16	24x1.5	1/2	
		HD-GE-20S-BB-12	HD-GE-20S-BB-12-SS	20	30x2	3/4			
		HD-GE-25S-BB-16	HD-GE-25S-BB-16-SS	25	36x2	1			
		HD-GE-30S-BB-20	HD-GE-30S-BB-20-SS	30	42x2	1.1/4			
		315	HD-GE-38S-BB-24	HD-GE-38S-BB-24-SS	38	52x2	1.1/2		

GE-BB

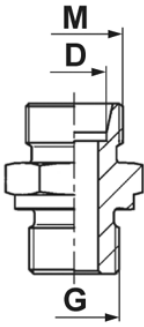
description	series	press. [bar]	code (galvanized steel)	code (AISI 316)	D [mm]	M [mm]	G [mm]		
Connector with metric thread, DIN 3852-B seal 	L	315	HD-GE-06L-MB-10	HD-GE-06L-MB-10-SS	6	12x1.5	10x1		
			HD-GE-08L-MB-12	HD-GE-08L-MB-12-SS	8	14x1.5	12x1.5		
			HD-GE-10L-MB-14	HD-GE-10L-MB-14-SS	10	16x1.5	14x1.5		
			HD-GE-12L-MB-16	HD-GE-12L-MB-16-SS	12	18x1.5	16x1.5		
			HD-GE-15L-MB-18	HD-GE-15L-MB-18-SS	15	22x1.5	18x1.5		
			HD-GE-18L-MB-22	HD-GE-18L-MB-22-SS	18	26x1.5	22x1.5		
		160	HD-GE-22L-MB-26	HD-GE-22L-MB-26-SS	22	30x2	26x1.5		
			HD-GE-28L-MB-33	HD-GE-28L-MB-33-SS	28	36x2	33x2		
			HD-GE-35L-MB-42	HD-GE-35L-MB-42-SS	35	45x2	42x2		
			HD-GE-42L-MB-48	HD-GE-42L-MB-48-SS	42	52x2	48x2		
			S	630	HD-GE-06S-MB-12	HD-GE-06S-MB-12-SS	6	14x1.5	12x1.5
					HD-GE-08S-MB-14	HD-GE-08S-MB-14-SS	8	16x1.5	14x1.5
	HD-GE-10S-MB-16	HD-GE-10S-MB-16-SS			10	18x1.5	16x1.5		
	HD-GE-12S-MB-18	HD-GE-12S-MB-18-SS			12	20x1.5	18x1.5		
	HD-GE-14S-MB-20	HD-GE-14S-MB-20-SS			14	22x1.5	20x1.5		
	400	HD-GE-16S-MB-22			HD-GE-16S-MB-22-SS	16	24x1.5	22x1.5	
		HD-GE-20S-MB-27	HD-GE-20S-MB-27-SS	20	30x2	27x2			
		HD-GE-25S-MB-33	HD-GE-25S-MB-33-SS	25	36x2	33x2			
		HD-GE-30S-MB-42	HD-GE-30S-MB-42-SS	30	42x2	42x2			
		315	HD-GE-38S-MB-48	HD-GE-38S-MB-48-SS	38	52x2	48x2		

GE-MB

HIGH PRESSURE - DIN 2353 connectors

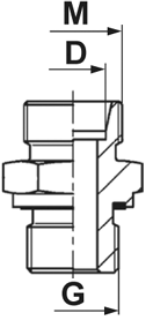
description	series	press. [bar]	code (galvanized steel)	code (AISI 316)	D [mm]	M [mm]	G [BSP]
Connector with BSP thread, DIN 3852-E seal  GE-BE	LL	100	HD-GE-04LL-BE-02	HD-GE-04LL-BE-02-SS	4	8x1	1/8
			HD-GE-06LL-BE-02	HD-GE-06LL-BE-02-SS	6	10x1	1/8
			HD-GE-08LL-BE-02	HD-GE-08LL-BE-02-SS	8	12x1	1/8
	L	315	HD-GE-06L-BE-02	HD-GE-06L-BE-02-SS	6	2x1.5	1/8
			HD-GE-08L-BE-04	HD-GE-08L-BE-04-SS	8	14x1.5	1/4
			HD-GE-10L-BE-04	HD-GE-10L-BE-04-SS	10	16x1.5	1/4
			HD-GE-12L-BE-06	HD-GE-12L-BE-06-SS	12	18x1.5	3/8
			HD-GE-15L-BE-08	HD-GE-15L-BE-08-SS	15	22x1.5	1/2
			HD-GE-18L-BE-08	HD-GE-18L-BE-08-SS	18	26x1.5	1/2
			HD-GE-22L-BE-12	HD-GE-22L-BE-12-SS	22	30x2	3/4
			HD-GE-28L-BE-16	HD-GE-28L-BE-16-SS	28	36x2	1
			HD-GE-35L-BE-20	HD-GE-35L-BE-20-SS	35	45x2	1.1/4
	S	630	HD-GE-06S-BE-04	HD-GE-06S-BE-04-SS	6	14x1.5	1/4
			HD-GE-08S-BE-04	HD-GE-08S-BE-04-SS	8	16x1.5	1/4
			HD-GE-10S-BE-06	HD-GE-10S-BE-06-SS	10	18x1.5	3/8
			HD-GE-12S-BE-06	HD-GE-12S-BE-06-SS	12	20x1.5	3/8
			HD-GE-14S-BE-08	HD-GE-14S-BE-08-SS	14	22x1.5	1/2
			HD-GE-16S-BE-08	HD-GE-16S-BE-08-SS	16	24x1.5	1/2
		400	HD-GE-20S-BE-12	HD-GE-20S-BE-12-SS	20	30x2	3/4
			HD-GE-25S-BE-16	HD-GE-25S-BE-16-SS	25	36x2	1
			HD-GE-30S-BE-20	HD-GE-30S-BE-20-SS	30	42x2	1.1/4
			HD-GE-38S-BE-24	HD-GE-38S-BE-24-SS	38	52x2	1.1/2

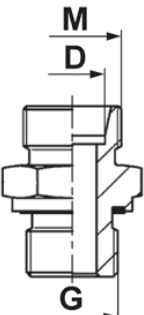
description	series	press. [bar]	code (galvanized steel)	code (AISI 316)	D [mm]	M [mm]	G [mm]
Connector with metric thread, DIN 3852-E seal  GE-ME	LL	100	HD-GE-04LL-ME-08	HD-GE-04LL-ME-08-SS	4	8x1	8x1
			HD-GE-06LL-ME-10	HD-GE-06LL-ME-10-SS	6	10x1	10x1
			HD-GE-08LL-ME-10	HD-GE-08LL-ME-10-SS	8	12x1	10x1
	L	315	HD-GE-06L-ME-10	HD-GE-06L-ME-10-SS	6	12x1.5	10x1
			HD-GE-08L-ME-12	HD-GE-08L-ME-12-SS	8	14x1.5	12x1.5
			HD-GE-10L-ME-14	HD-GE-10L-ME-14-SS	10	16x1.5	14x1.5
			HD-GE-12L-ME-16	HD-GE-12L-ME-16-SS	12	18x1.5	16x1.5
			HD-GE-15L-ME-18	HD-GE-15L-ME-18-SS	15	22x1.5	18x1.5
			HD-GE-18L-ME-22	HD-GE-18L-ME-22-SS	18	26x1.5	22x1.5
			HD-GE-22L-ME-26	HD-GE-22L-ME-26-SS	22	30x2	26x1.5
			HD-GE-28L-ME-33	HD-GE-28L-ME-33-SS	28	36x2	33x2
			HD-GE-35L-ME-42	HD-GE-35L-ME-42-SS	35	45x2	42x2
	S	630	HD-GE-06S-ME-12	HD-GE-06S-ME-12-SS	6	14x1.5	12x1.5
			HD-GE-08S-ME-14	HD-GE-08S-ME-14-SS	8	16x1.5	14x1.5
			HD-GE-10S-ME-16	HD-GE-10S-ME-16-SS	10	18x1.5	16x1.5
			HD-GE-12S-ME-18	HD-GE-12S-ME-18-SS	12	20x1.5	18x1.5
			HD-GE-14S-ME-20	HD-GE-14S-ME-20-SS	14	22x1.5	20x1.5
			HD-GE-16S-ME-22	HD-GE-16S-ME-22-SS	16	24x1.5	22x1.5
		400	HD-GE-20S-ME-27	HD-GE-20S-ME-27-SS	20	30x2	27x2
			HD-GE-25S-ME-33	HD-GE-25S-ME-33-SS	25	36x2	33x2
			HD-GE-30S-ME-42	HD-GE-30S-ME-42-SS	30	42x2	42x2
			HD-GE-38S-ME-48	HD-GE-38S-ME-48-SS	38	52x2	48x2

HIGH PRESSURE - DIN 2353 connectors

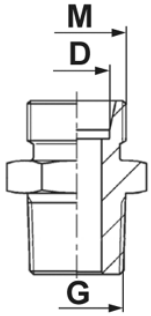
description	series	press. [bar]	code (galvanized steel)	code (AISI 316)	D [mm]	M [mm]	G [BSPT]		
Connector with BSPT tapered thread  GE-BT	L	315	HD-GE-06L-BT-02	HD-GE-06L-BT-02-SS	6	12x1.5	1/8		
			HD-GE-08L-BT-04	HD-GE-08L-BT-04-SS	8	14x1.5	1/4		
			HD-GE-10L-BT-04	HD-GE-10L-BT-04-SS	10	16x1.5	1/4		
			HD-GE-12L-BT-06	HD-GE-12L-BT-06-SS	12	18x1.5	3/8		
			HD-GE-15L-BT-08	HD-GE-15L-BT-08-SS	15	22x1.5	1/2		
			HD-GE-18L-BT-08	HD-GE-18L-BT-08-SS	18	26x1.5	1/2		
		160	HD-GE-22L-BT-12	HD-GE-22L-BT-12-SS	22	30x2	3/4		
			HD-GE-28L-BT-16	HD-GE-28L-BT-16-SS	28	36x2	1		
			HD-GE-35L-BT-20	HD-GE-35L-BT-20-SS	35	45x2	1.1/4		
			HD-GE-42L-BT-24	HD-GE-42L-BT-24-SS	42	52x2	1.1/2		
			S	630	HD-GE-06S-BT-04	HD-GE-06S-BT-04-SS	6	14x1.5	1/4
					HD-GE-08S-BT-04	HD-GE-08S-BT-04-SS	8	16x1.5	1/4
	HD-GE-10S-BT-06	HD-GE-10S-BT-06-SS			10	18x1.5	3/8		
	HD-GE-12S-BT-06	HD-GE-12S-BT-06-SS			12	20x1.5	3/8		
	HD-GE-14S-BT-08	HD-GE-14S-BT-08-SS			14	22x1.5	1/2		
	400	HD-GE-16S-BT-08			HD-GE-16S-BT-08-SS	16	24x1.5	1/2	
		HD-GE-20S-BT-12	HD-GE-20S-BT-12-SS	20	30x2	3/4			
		HD-GE-25S-BT-16	HD-GE-25S-BT-16-SS	25	36x2	1			
		HD-GE-30S-BT-20	HD-GE-30S-BT-20-SS	30	42x2	1.1/4			
		315	HD-GE-38S-BT-24	HD-GE-38S-BT-24-SS	38	52x2	1.1/2		

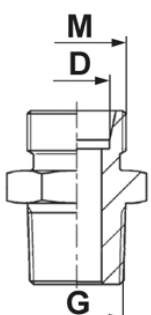
description	series	press. [bar]	code (galvanized steel)	code (AISI 316)	D [mm]	M [mm]	G [NPT]		
Connector with NPT tapered thread  GE-NT	L	315	HD-GE-06L-NT-02	HD-GE-06L-NT-02-SS	6	12x1.5	1/8		
			HD-GE-08L-NT-04	HD-GE-08L-NT-04-SS	8	14x1.5	1/4		
			HD-GE-10L-NT-04	HD-GE-10L-NT-04-SS	10	16x1.5	1/4		
			HD-GE-12L-NT-06	HD-GE-12L-NT-06-SS	12	18x1.5	3/8		
			HD-GE-15L-NT-08	HD-GE-15L-NT-08-SS	15	22x1.5	1/2		
			HD-GE-18L-NT-08	HD-GE-18L-NT-08-SS	18	26x1.5	1/2		
		160	HD-GE-22L-NT-12	HD-GE-22L-NT-12-SS	22	30x2	3/4		
			HD-GE-28L-NT-16	HD-GE-28L-NT-16-SS	28	36x2	1		
			HD-GE-35L-NT-20	HD-GE-35L-NT-20-SS	35	45x2	1.1/4		
			HD-GE-42L-NT-24	HD-GE-42L-NT-24-SS	42	52x2	1.1/2		
			S	630	HD-GE-06S-NT-04	HD-GE-06S-NT-04-SS	6	14x1.5	1/4
					HD-GE-08S-NT-04	HD-GE-08S-NT-04-SS	8	16x1.5	1/4
	HD-GE-10S-NT-06	HD-GE-10S-NT-06-SS			10	18x1.5	3/8		
	HD-GE-12S-NT-06	HD-GE-12S-NT-06-SS			12	20x1.5	3/8		
	HD-GE-14S-NT-08	HD-GE-14S-NT-08-SS			14	22x1.5	1/2		
	400	HD-GE-16S-NT-08			HD-GE-16S-NT-08-SS	16	24x1.5	1/2	
		HD-GE-20S-NT-12	HD-GE-20S-NT-12-SS	20	30x2	3/4			
		HD-GE-25S-NT-16	HD-GE-25S-NT-16-SS	25	36x2	1			
		HD-GE-30S-NT-20	HD-GE-30S-NT-20-SS	30	42x2	1.1/4			
		315	HD-GE-38S-NT-24	HD-GE-38S-NT-24-SS	38	52x2	1.1/2		

HIGH PRESSURE - DIN 2353 connectors

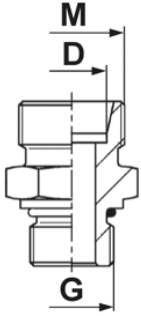
description	series	press. [bar]	code (galvanized steel)	code (AISI 316)	D [mm]	M [mm]	G [UN-UNF]
Connector with UN-UNF thread, O-ring seal  GE-UN	L	315	HD-GE-06L-UN-07	HD-GE-06L-UN-07-SS	6	12x1.5	7/16-20
			HD-GE-08L-UN-08	HD-GE-08L-UN-08-SS	8	14x1.5	1/2-20
			HD-GE-10L-UN-08	HD-GE-10L-UN-08-SS	10	16x1.5	1/2-20
			HD-GE-12L-UN-09	HD-GE-12L-UN-09-SS	12	18x1.5	9/16-18
			HD-GE-15L-UN-12	HD-GE-15L-UN-12-SS	15	22x1.5	3/4-16
			HD-GE-18L-UN-12	HD-GE-18L-UN-12-SS	18	26x1.5	3/4-16
		160	HD-GE-22L-UN-17	HD-GE-22L-UN-17-SS	22	30x2	1.1/16-12
			HD-GE-28L-UN-21	HD-GE-28L-UN-21-SS	28	36x2	1.5/16-12
			HD-GE-35L-UN-26	HD-GE-35L-UN-26-SS	35	45x2	1.5/8-12
			HD-GE-42L-UN-30	HD-GE-42L-UN-30-SS	42	52x2	1.7/8-12
	S	630	HD-GE-06S-UN-08	HD-GE-06S-UN-08-SS	6	14x1.5	1/2-20
			HD-GE-08S-UN-08	HD-GE-08S-UN-08-SS	8	16x1.5	1/2-20
			HD-GE-10S-UN-09	HD-GE-10S-UN-09-SS	10	18x1.5	9/16-18
			HD-GE-12S-UN-09	HD-GE-12S-UN-09-SS	12	20x1.5	9/16-18
			HD-GE-14S-UN-12	HD-GE-14S-UN-12-SS	14	22x1.5	3/4-16
			HD-GE-16S-UN-12	HD-GE-16S-UN-12-SS	16	24x1.5	3/4-16
		400	HD-GE-20S-UN-17	HD-GE-20S-UN-17-SS	20	30x2	1.1/16-12
			HD-GE-25S-UN-21	HD-GE-25S-UN-21-SS	25	36x2	1.5/16-12
			HD-GE-30S-UN-26	HD-GE-30S-UN-26-SS	30	42x2	1.5/8-12
			HD-GE-38S-UN-30	HD-GE-38S-UN-30-SS	38	52x2	1.7/8-12

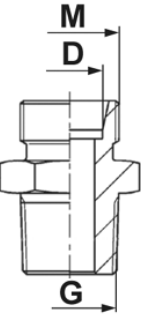
description	series	press. [bar]	code (galvanized steel)	code (AISI 316)	D [mm]	M [mm]	G [mm]
Connector with metric tapered thread  GE-MT	L	315	HD-GE-06L-MT-10	HD-GE-06L-MT-10-SS	6	12x1.5	10x1
			HD-GE-08L-MT-12	HD-GE-08L-MT-12-SS	8	14x1.5	12x1.5
			HD-GE-10L-MT-14	HD-GE-10L-MT-14-SS	10	16x1.5	14x1.5
			HD-GE-12L-MT-16	HD-GE-12L-MT-16-SS	12	18x1.5	16x1.5
			HD-GE-15L-MT-18	HD-GE-15L-MT-18-SS	15	22x1.5	18x1.5
			HD-GE-18L-MT-22	HD-GE-18L-MT-22-SS	18	26x1.5	22x1.5
	M	630	HD-GE-06S-MT-12	HD-GE-06S-MT-12-SS	6	14x1.5	12x1.5
			HD-GE-08S-MT-14	HD-GE-08S-MT-14-SS	8	16x1.5	14x1.5
			HD-GE-10S-MT-16	HD-GE-10S-MT-16-SS	10	18x1.5	16x1.5
			HD-GE-12S-MT-18	HD-GE-12S-MT-18-SS	12	20x1.5	18x1.5
			HD-GE-14S-MT-20	HD-GE-14S-MT-20-SS	14	22x1.5	20x1.5
		400	HD-GE-16S-MT-22	HD-GE-16S-MT-22-SS	16	24x1.5	22x1.5

HIGH PRESSURE - DIN 2353 connectors

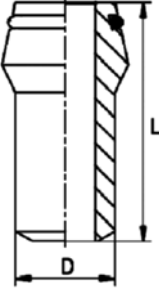
description	series	press. [bar]	code (black steel)	code (AISI 316)	D [mm]	g [mm]	L [mm]
Connector with weld-in end. 24° cone. o-ring seal 	L/S	520	HD-ASF-06X1,75	-	6	1.75	31
			-	HD-ASF-06X1,5-SS	6	1.5	31
			HD-ASF-08X2,0	HD-ASF-08X2,0-SS	8	2.0	31
		315	HD-ASF-10X1,5	HD-ASF-10X1,5-SS	10	1.5	32.5
		400	HD-ASF-10X2,0	HD-ASF-10X2,0-SS	10	2.0	32.5
		315	HD-ASF-12X1,5	HD-ASF-12X1,5-SS	12	1.5	32.5
		400	HD-ASF-12X2,0	HD-ASF-12X2,0-SS	12	2.0	32.5
	470	HD-ASF-12X2,5	HD-ASF-12X2,5-SS	12	2.5	32.5	
	L	315	HD-ASF-15X2,5	HD-ASF-15X2,5-SS	15	2.5	34
			HD-ASF-18X2,5	HD-ASF-18X2,5-SS	18	2.5	35.5
		160	HD-ASF-22X2,5	HD-ASF-22X2,5-SS	22	2.5	38.5
			HD-ASF-28X2,5	HD-ASF-28X2,5-SS	28	2.5	41.5
			HD-ASF-35X3,0	HD-ASF-35X3,0-SS	35	3.0	47.5
	S	400	HD-ASF-42X3,0	HD-ASF-42X3,0-SS	42	3.0	47.5
			HD-ASF-14X3,0	HD-ASF-14X3,0-SS	14	3.0	38.5
		250	HD-ASF-16X2,0	HD-ASF-16X2,0-SS	16	2.0	39
		315	HD-ASF-16X2,5	HD-ASF-16X2,5-SS	16	2.5	39
		400	HD-ASF-16X3,0	HD-ASF-16X3,0-SS	16	3.0	39
		250	HD-ASF-20X2,5	HD-ASF-20X2,5-SS	20	2.5	45
		315	HD-ASF-20X3,0	HD-ASF-20X3,0-SS	20	3.0	45
		400	HD-ASF-20X4,0	HD-ASF-20X4,0-SS	20	4.0	45
		250	HD-ASF-25X3,0	HD-ASF-25X3,0-SS	25	3.0	49.5
		315	HD-ASF-25X4,0	HD-ASF-25X4,0-SS	25	4.0	49.5
		400	HD-ASF-25X5,0	HD-ASF-25X5,0-SS	25	5.0	49.5
		160	HD-ASF-30X3,0	HD-ASF-30X3,0-SS	30	3.0	52
		250	HD-ASF-30X4,0	HD-ASF-30X4,0-SS	30	4.0	52
		315	HD-ASF-30X5,0	HD-ASF-30X5,0-SS	30	5.0	52
			HD-ASF-30X6,0	HD-ASF-30X6,0-SS	30	6.0	52
		250	HD-ASF-38X5,0	HD-ASF-38X5,0-SS	38	5.0	56.5
	315	HD-ASF-38X6,0	HD-ASF-38X6,0-SS	38	6.0	56.5	

ASF

HIGH PRESSURE - DIN 2353 connectors

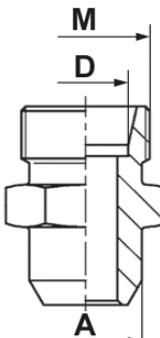
description	series	press. [bar]	code (black steel)	code (AISI 316)	D [mm]	M [mm]	A [mm]
Connector with weld-in end 	L	315	HD-AS-06L	HD-AS-06L-SS	6	12x1.5	10
			HD-AS-08L	HD-AS-08L-SS	8	14x1.5	12
			HD-AS-10L	HD-AS-10L-SS	10	16x1.5	14
			HD-AS-12L	HD-AS-12L-SS	12	18x1.5	16
			HD-AS-15L	HD-AS-15L-SS	15	22x1.5	19
			HD-AS-18L	HD-AS-18L-SS	18	26x1.5	22
		160	HD-AS-22L	HD-AS-22L-SS	22	30x2	27
			HD-AS-28L	HD-AS-28L-SS	28	36x2	32
			HD-AS-35L	HD-AS-35L-SS	35	45x2	40
			HD-AS-42L	HD-AS-42L-SS	42	52x2	46
	S	630	HD-AS-06S	HD-AS-06S-SS	6	14x1.5	11
			HD-AS-08S	HD-AS-08S-SS	8	16x1.5	13
			HD-AS-10S	HD-AS-10S-SS	10	18x1.5	15
			HD-AS-12S	HD-AS-12S-SS	12	20x1.5	17
			HD-AS-14S	HD-AS-14S-SS	14	22x1.5	19
		400	HD-AS-16S	HD-AS-16S-SS	16	24x1.5	21
			HD-AS-20S	HD-AS-20S-SS	20	30x2	26
			HD-AS-25S	HD-AS-25S-SS	25	36x2	31
			HD-AS-30S	HD-AS-30S-SS	30	42x2	36
			HD-AS-38S	HD-AS-38S-SS	38	52x2	44

AS

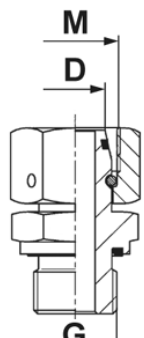
description	series	press. [bar]	code (galvanized steel)	code (AISI 316)	D [mm]	M [mm]	G [BSP]
Adjustable metric connector with BSP thread, DIN 3852-E seal 	L	315	HD-EVGEO-06L-BE-02	HD-EVGEO-06L-BE-02-SS	6	12x1.5	1/8
			HD-EVGEO-08L-BE-04	HD-EVGEO-08L-BE-04-SS	8	14x1.5	1/4
			HD-EVGEO-10L-BE-04	HD-EVGEO-10L-BE-04-SS	10	16x1.5	1/4
			HD-EVGEO-12L-BE-06	HD-EVGEO-12L-BE-06-SS	12	18x1.5	3/8
			HD-EVGEO-15L-BE-08	HD-EVGEO-15L-BE-08-SS	15	22x1.5	1/2
			HD-EVGEO-18L-BE-08	HD-EVGEO-18L-BE-08-SS	18	26x1.5	1/2
		160	HD-EVGEO-22L-BE-12	HD-EVGEO-22L-BE-12-SS	22	30x2	3/4
			HD-EVGEO-28L-BE-16	HD-EVGEO-28L-BE-16-SS	28	36x2	1
			HD-EVGEO-35L-BE-20	HD-EVGEO-35L-BE-20-SS	35	45x2	1.1/4
			HD-EVGEO-42L-BE-24	HD-EVGEO-42L-BE-24-SS	42	52x2	1.1/2
	S	630	HD-EVGEO-06S-BE-04	HD-EVGEO-06S-BE-04-SS	6	14x1.5	1/4
			HD-EVGEO-08S-BE-04	HD-EVGEO-08S-BE-04-SS	8	16x1.5	1/4
			HD-EVGEO-10S-BE-06	HD-EVGEO-10S-BE-06-SS	10	18x1.5	3/8
			HD-EVGEO-12S-BE-06	HD-EVGEO-12S-BE-06-SS	12	20x1.5	3/8
			HD-EVGEO-14S-BE-08	HD-EVGEO-14S-BE-08-SS	14	22x1.5	1/2
		400	HD-EVGEO-16S-BE-08	HD-EVGEO-16S-BE-08-SS	16	24x1.5	1/2
			HD-EVGEO-20S-BE-12	HD-EVGEO-20S-BE-12-SS	20	30x2	3/4
			HD-EVGEO-25S-BE-16	HD-EVGEO-25S-BE-16-SS	25	36x2	1
			HD-EVGEO-30S-BE-20	HD-EVGEO-30S-BE-20-SS	30	42x2	1.1/4
			HD-EVGEO-38S-BE-24	HD-EVGEO-38S-BE-24-SS	38	52x2	1.1/2

EVGEO - BE

HIGH PRESSURE - DIN 2353 connectors

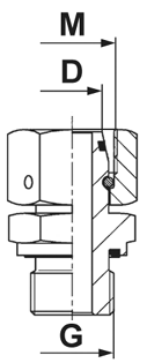
description	series	press. [bar]	code (galvanized steel)	code (AISI 316)	D [mm]	M [mm]	G [mm]		
Adjustable connector with metric thread, DIN 3852-E seal 	L	315	HD-EVGEO-06L-ME-10	HD-EVGEO-06L-ME-10-SS	6	12x1.5	10x1		
			HD-EVGEO-08L-ME-12	HD-EVGEO-08L-ME-12-SS	8	14x1.5	12x1.5		
			HD-EVGEO-10L-ME-14	HD-EVGEO-10L-ME-14-SS	10	16x1.5	14x1.5		
			HD-EVGEO-12L-ME-16	HD-EVGEO-12L-ME-16-SS	12	18x1.5	16x1.5		
			HD-EVGEO-15L-ME-18	HD-EVGEO-15L-ME-18-SS	15	22x1.5	18x1.5		
			HD-EVGEO-18L-ME-22	HD-EVGEO-18L-ME-22-SS	18	26x1.5	22x1.5		
		160	HD-EVGEO-22L-ME-26	HD-EVGEO-22L-ME-26-SS	22	30x2	26x1.5		
			HD-EVGEO-28L-ME-33	HD-EVGEO-28L-ME-33-SS	28	36x2	33x2		
			HD-EVGEO-35L-ME-42	HD-EVGEO-35L-ME-42-SS	35	45x2	42x2		
			HD-EVGEO-42L-ME-48	HD-EVGEO-42L-ME-48-SS	42	52x2	48x2		
			S	630	HD-EVGEO-06S-ME-12	HD-EVGEO-06S-ME-12-SS	6	14x1.5	12x1.5
					HD-EVGEO-08S-ME-14	HD-EVGEO-08S-ME-14-SS	8	16x1.5	14x1.5
	HD-EVGEO-10S-ME-16	HD-EVGEO-10S-ME-16-SS			10	18x1.5	16x1.5		
	HD-EVGEO-12S-ME-18	HD-EVGEO-12S-ME-18-SS			12	20x1.5	18x1.5		
	HD-EVGEO-14S-ME-20	HD-EVGEO-14S-ME-20-SS			14	22x1.5	20x1.5		
	HD-EVGEO-16S-ME-22	HD-EVGEO-16S-ME-22-SS			16	24x1.5	22x1.5		
	400	HD-EVGEO-20S-ME-27	HD-EVGEO-20S-ME-27-SS	20	30x2	27x2			
		HD-EVGEO-25S-ME-33	HD-EVGEO-25S-ME-33-SS	25	36x2	33x2			
		HD-EVGEO-30S-ME-42	HD-EVGEO-30S-ME-42-SS	30	42x2	42x2			
		315	HD-EVGEO-38S-ME-48	HD-EVGEO-38S-ME-48-SS	38	52x2	48x2		

EVGEO - ME

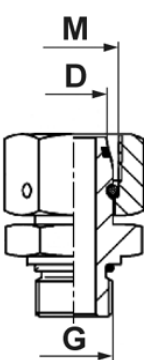
description	series	press. [bar]	code (galvanized steel)	code (AISI 316)	D [mm]	M [mm]	G [UN-UNF]		
Adjustable connector with UN-UNF thread, O-ring seal 	L	315	HD-EVGEO-06L-UN-07	HD-EVGEO-06L-UN-07-SS	6	12x1.5	7/16-20		
			HD-EVGEO-08L-UN-07	HD-EVGEO-08L-UN-07-SS	8	14x1.5	7/16-20		
			HD-EVGEO-10L-UN-09	HD-EVGEO-10L-UN-09-SS	10	16x1.5	9/16-18		
			HD-EVGEO-12L-UN-12	HD-EVGEO-12L-UN-12-SS	12	18x1.5	3/4-16		
			HD-EVGEO-15L-UN-14	HD-EVGEO-15L-UN-14-SS	15	22x1.5	7/8-14		
			HD-EVGEO-18L-UN-14	HD-EVGEO-18L-UN-14-SS	18	26x1.5	7/8-14		
		160	HD-EVGEO-22L-UN-17	HD-EVGEO-22L-UN-17-SS	22	30x2	1.1/16-12		
			HD-EVGEO-28L-UN-21	HD-EVGEO-28L-UN-21-SS	28	36x2	1.5/16-12		
			HD-EVGEO-35L-UN-26	HD-EVGEO-35L-UN-26-SS	35	45x2	1.5/8-12		
			HD-EVGEO-42L-UN-30	HD-EVGEO-42L-UN-30-SS	42	52x2	1.7/8-12		
			S	630	HD-EVGEO-06S-UN-07	HD-EVGEO-06S-UN-07-SS	6	14x1.5	7/16-20
					HD-EVGEO-08S-UN-09	HD-EVGEO-08S-UN-09-SS	8	16x1.5	9/16-18
	HD-EVGEO-10S-UN-09	HD-EVGEO-10S-UN-09-SS			10	18x1.5	9/16-18		
	HD-EVGEO-12S-UN-12	HD-EVGEO-12S-UN-12-SS			12	20x1.5	3/4-16		
	HD-EVGEO-14S-UN-14	HD-EVGEO-14S-UN-14-SS			14	22x1.5	7/8-14		
	HD-EVGEO-16S-UN-14	HD-EVGEO-16S-UN-14-SS			16	24x1.5	7/8-14		
	400	HD-EVGEO-20S-UN-17	HD-EVGEO-20S-UN-17-SS	20	30x2	1.1/16-12			
		HD-EVGEO-25S-UN-21	HD-EVGEO-25S-UN-21-SS	25	36x2	1.5/16-12			
		HD-EVGEO-30S-UN-26	HD-EVGEO-30S-UN-26-SS	30	42x2	1.5/8-12			
		315	HD-EVGEO-38S-UN-30	HD-EVGEO-38S-UN-30-SS	38	52x2	1.7/8-12		

EVGEO - UN

HIGH PRESSURE - DIN 2353 connectors

description	series	press. [bar]	code (galvanized steel)	code (AISI 316)	D [mm]	M [mm]	G [BSP]		
Connector with BSP female thread  GAI - B	L	315	HD-GAI-06L-B-02	HD-GAI-06L-B-02-SS	6	12x1.5	1/8		
			HD-GAI-08L-B-04	HD-GAI-08L-B-04-SS	8	14x1.5	1/4		
			HD-GAI-10L-B-04	HD-GAI-10L-B-04-SS	10	16x1.5	1/4		
			HD-GAI-12L-B-06	HD-GAI-12L-B-06-SS	12	18x1.5	3/8		
			HD-GAI-15L-B-08	HD-GAI-15L-B-08-SS	15	22x1.5	1/2		
			HD-GAI-18L-B-08	HD-GAI-18L-B-08-SS	18	26x1.5	1/2		
		160	HD-GAI-22L-B-12	HD-GAI-22L-B-12-SS	22	30x2	3/4		
			HD-GAI-28L-B-16	HD-GAI-28L-B-16-SS	28	36x2	1		
			HD-GAI-35L-B-20	HD-GAI-35L-B-20-SS	35	45x2	1.1/4		
			HD-GAI-42L-B-24	HD-GAI-42L-B-24-SS	42	52x2	1.1/2		
			S	630	HD-GAI-06S-B-04	HD-GAI-06S-B-04-SS	6	14x1.5	1/4
					HD-GAI-08S-B-04	HD-GAI-08S-B-04-SS	8	16x1.5	1/4
	HD-GAI-10S-B-06	HD-GAI-10S-B-06-SS			10	18x1.5	3/8		
	400	HD-GAI-12S-B-06		HD-GAI-12S-B-06-SS	12	20x1.5	3/8		
		HD-GAI-14S-B-08		HD-GAI-14S-B-08-SS	14	22x1.5	1/2		
		HD-GAI-16S-B-08		HD-GAI-16S-B-08-SS	16	24x1.5	1/2		
	315	HD-GAI-20S-B-12	HD-GAI-20S-B-12-SS	20	30x2	3/4			
		HD-GAI-25S-B-16	HD-GAI-25S-B-16-SS	25	36x2	1			
		HD-GAI-30S-B-20	HD-GAI-30S-B-20-SS	30	42x2	1.1/4			
		HD-GAI-38S-B-24	HD-GAI-38S-B-24-SS	38	52x2	1.1/2			

description	series	press. [bar]	code (galvanized steel)	code (AISI 316)	D [mm]	M [mm]	G [mm]		
Connector with metric female thread  GAI - M	L	315	HD-GAI-06L-M-10	HD-GAI-06L-M-10-SS	6	12x1.5	10x1		
			HD-GAI-08L-M-12	HD-GAI-08L-M-12-SS	8	14x1.5	12x1.5		
			HD-GAI-10L-M-14	HD-GAI-10L-M-14-SS	10	16x1.5	14x1.5		
			HD-GAI-12L-M-16	HD-GAI-12L-M-16-SS	12	18x1.5	16x1.5		
			HD-GAI-15L-M-18	HD-GAI-15L-M-18-SS	15	22x1.5	18x1.5		
			HD-GAI-18L-M-22	HD-GAI-18L-M-22-SS	18	26x1.5	22x1.5		
		160	HD-GAI-22L-M-26	HD-GAI-22L-M-26-SS	22	30x2	26x1.5		
			HD-GAI-28L-M-33	HD-GAI-28L-M-33-SS	28	36x2	33x2		
			HD-GAI-35L-M-42	HD-GAI-35L-M-42-SS	35	45x2	42x2		
			HD-GAI-42L-M-48	HD-GAI-42L-M-48-SS	42	52x2	48x2		
			S	630	HD-GAI-06S-M-12	HD-GAI-06S-M-12-SS	6	14x1.5	12x1.5
					HD-GAI-08S-M-14	HD-GAI-08S-M-14-SS	8	16x1.5	14x1.5
	HD-GAI-10S-M-16	HD-GAI-10S-M-16-SS			10	18x1.5	16x1.5		
	400	HD-GAI-12S-M-18		HD-GAI-12S-M-18-SS	12	20x1.5	18x1.5		
		HD-GAI-14S-M-20		HD-GAI-14S-M-20-SS	14	22x1.5	20x1.5		
		HD-GAI-16S-M-22		HD-GAI-16S-M-22-SS	16	24x1.5	22x1.5		
	315	HD-GAI-20S-M-27	HD-GAI-20S-M-27-SS	20	30x2	27x2			
		HD-GAI-25S-M-33	HD-GAI-25S-M-33-SS	25	36x2	33x2			
		HD-GAI-30S-M-42	HD-GAI-30S-M-42-SS	30	42x2	42x2			
		HD-GAI-38S-M-48	HD-GAI-38S-M-48-SS	38	52x2	48x2			

HIGH PRESSURE - DIN 2353 connectors

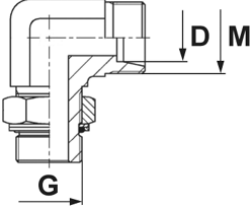
description	series	press. [bar]	code (galvanized steel)	code (AISI 316)	D [mm]	M [mm]	G [BSP]	
Adjustable 90° connector with BSP thread, ISO 1179-G seal 	L	315	HD-WE-06L-BG-02	-	6	12x1.5	1/8	
			HD-WE-08L-BG-04	-	8	14x1.5	1/4	
			HD-WE-10L-BG-04	-	10	16x1.5	1/4	
		250	HD-WE-12L-BG-06	-	12	18x1.5	3/8	
			HD-WE-15L-BG-08	-	15	22x1.5	1/2	
			HD-WE-18L-BG-08	-	18	26x1.5	1/2	
		160	HD-WE-22L-BG-12	-	22	30x2	3/4	
			HD-WE-28L-BG-16	-	28	36x2	1	
			HD-WE-35L-BG-20	-	35	45x2	1.1/4	
			HD-WE-42L-BG-24	-	42	52x2	1.1/2	
		S	315	HD-WE-06S-BG-04	-	6	14x1.5	1/4
				HD-WE-08S-BG-04	-	8	16x1.5	1/4
	250		HD-WE-10S-BG-06	-	10	18x1.5	3/8	
			HD-WE-12S-BG-06	-	12	20x1.5	3/8	
			HD-WE-14S-BG-08	-	14	22x1.5	1/2	
			HD-WE-16S-BG-08	-	16	24x1.5	1/2	
	200		HD-WE-20S-BG-12	-	20	30x2	3/4	
			HD-WE-25S-BG-16	-	25	36x2	1	
	160		HD-WE-30S-BG-20	-	30	42x2	1.1/4	
			HD-WE-38S-BG-24	-	38	52x2	1.1/2	

WE - BG

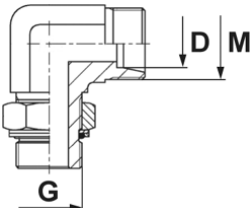
description	series	press. [bar]	code (galvanized steel)	code (AISI 316)	D [mm]	M [mm]	G [mm]		
Adjustable 90° connector with metric thread, ISO 6149-G seal 	L	315	HD-WE-06L-MG-10	-	6	12x1.5	10x1		
			HD-WE-08L-MG-12	-	8	14x1.5	12x1.5		
			HD-WE-10L-MG-14	-	10	16x1.5	14x1.5		
			HD-WE-12L-MG-16	-	12	18x1.5	16x1.5		
			HD-WE-15L-MG-18	-	15	22x1.5	18x1.5		
		250	HD-WE-18L-MG-22	-	18	26x1.5	22x1.5		
			HD-WE-22L-MG-27	-	22	30x2	27x2		
			HD-WE-28L-MG-33	-	28	36x2	33x2		
		160	HD-WE-35L-MG-42	-	35	45x2	42x2		
			HD-WE-42L-MG-48	-	42	52x2	48x2		
			S	315	HD-WE-06S-MG-12	-	6	14x1.5	12x1.5
					HD-WE-08S-MG-14	-	8	16x1.5	14x1.5
	HD-WE-10S-MG-16	-			10	18x1.5	16x1.5		
	250	HD-WE-12S-MG-18		-	12	20x1.5	18x1.5		
		HD-WE-14S-MG-20	-	14	22x1.5	20x1.5			
		HD-WE-16S-MG-22	-	16	24x1.5	22x1.5			
	160	HD-WE-20S-MG-27	-	20	30x2	27x2			
		HD-WE-25S-MG-33	-	25	36x2	33x2			
		HD-WE-30S-MG-42	-	30	42x2	42x2			
		HD-WE-38S-MG-48	-	38	52x2	48x2			

WE - MG

HIGH PRESSURE - DIN 2353 connectors

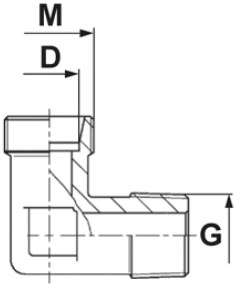
description	series	press. [bar]	code (galvanized steel)	code (AISI 316)	D [mm]	M [mm]	G [BSPT]
90° connector with BSPT tapered thread  WE - BT	L	315	HD-WE-06L-BT-02	HD-WE-06L-BT-02-SS	6	12x1.5	1/8
			HD-WE-08L-BT-04	HD-WE-08L-BT-04-SS	8	14x1.5	1/4
			HD-WE-10L-BT-04	HD-WE-10L-BT-04-SS	10	16x1.5	1/4
			HD-WE-12L-BT-06	HD-WE-12L-BT-06-SS	12	18x1.5	3/8
			HD-WE-15L-BT-08	HD-WE-15L-BT-08-SS	15	22x1.5	1/2
			HD-WE-18L-BT-08	HD-WE-18L-BT-08-SS	18	26x1.5	1/2
		160	HD-WE-22L-BT-12	HD-WE-22L-BT-12-SS	22	30x2	3/4
			HD-WE-28L-BT-16	HD-WE-28L-BT-16-SS	28	36x2	1
			HD-WE-35L-BT-20	HD-WE-35L-BT-20-SS	35	45x2	1.1/4
			HD-WE-42L-BT-24	HD-WE-42L-BT-24-SS	42	52x2	1.1/2
	S	630	HD-WE-06S-BT-04	HD-WE-06S-BT-04-SS	6	14x1.5	1/4
			HD-WE-08S-BT-04	HD-WE-08S-BT-04-SS	8	16x1.5	1/4
			HD-WE-10S-BT-06	HD-WE-10S-BT-06-SS	10	18x1.5	3/8
			HD-WE-12S-BT-06	HD-WE-12S-BT-06-SS	12	20x1.5	3/8
			HD-WE-14S-BT-08	HD-WE-14S-BT-08-SS	14	22x1.5	1/2
		400	HD-WE-16S-BT-08	HD-WE-16S-BT-08-SS	16	24x1.5	1/2
			HD-WE-20S-BT-12	HD-WE-20S-BT-12-SS	20	30x2	3/4
			HD-WE-25S-BT-16	HD-WE-25S-BT-16-SS	25	36x2	1
			HD-WE-30S-BT-20	HD-WE-30S-BT-20-SS	30	42x2	1.1/4
			315	HD-WE-38S-BT-24	HD-WE-38S-BT-24-SS	38	52x2

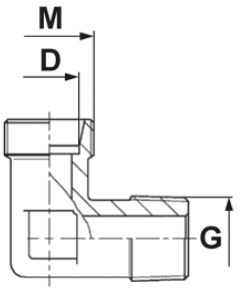
description	series	press. [bar]	code (galvanized steel)	code (AISI 316)	D [mm]	M [mm]	G [mm]
90° connector with metric tapered thread  WE - MT	L	315	HD-WE-06L-MT-10	HD-WE-06L-MT-10-SS	6	12x1.5	10x1
			HD-WE-08L-MT-12	HD-WE-08L-MT-12-SS	8	14x1.5	12x1.5
			HD-WE-10L-MT-14	HD-WE-10L-MT-14-SS	10	16x1.5	14x1.5
			HD-WE-12L-MT-16	HD-WE-12L-MT-16-SS	12	18x1.5	16x1.5
			HD-WE-15L-MT-18	HD-WE-15L-MT-18-SS	15	22x1.5	18x1.5
			HD-WE-18L-MT-22	HD-WE-18L-MT-22-SS	18	26x1.5	22x1.5
	S	630	HD-WE-06S-MT-12	HD-WE-06S-MT-12-SS	6	14x1.5	12x1.5
			HD-WE-08S-MT-14	HD-WE-08S-MT-14-SS	8	16x1.5	14x1.5
			HD-WE-10S-MT-16	HD-WE-10S-MT-16-SS	10	18x1.5	16x1.5
			HD-WE-12S-MT-18	HD-WE-12S-MT-18-SS	12	20x1.5	18x1.5
			HD-WE-14S-MT-20	HD-WE-14S-MT-20-SS	14	22x1.5	20x1.5
		400	HD-WE-16S-MT-22	HD-WE-16S-MT-22-SS	16	24x1.5	22x1.5

HIGH PRESSURE - DIN 2353 connectors

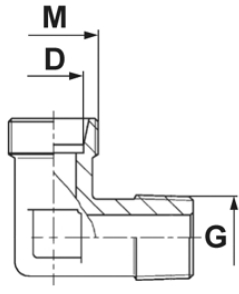
description	series	press. [bar]	code (galvanized steel)	code (AISI 316)	D [mm]	M [mm]	G [NPT]		
90° connector with NPT tapered thread  WE - NT	L	315	HD-WE-06L-NT-02	HD-WE-06L-NT-02-SS	6	12x1.5	1/8		
			HD-WE-08L-NT-04	HD-WE-08L-NT-04-SS	8	14x1.5	1/4		
			HD-WE-10L-NT-04	HD-WE-10L-NT-04-SS	10	16x1.5	1/4		
			HD-WE-12L-NT-06	HD-WE-12L-NT-06-SS	12	18x1.5	3/8		
			HD-WE-15L-NT-08	HD-WE-15L-NT-08-SS	15	22x1.5	1/2		
			HD-WE-18L-NT-08	HD-WE-18L-NT-08-SS	18	26x1.5	1/2		
		160	HD-WE-22L-NT-12	HD-WE-22L-NT-12-SS	22	30x2	3/4		
			HD-WE-28L-NT-16	HD-WE-28L-NT-16-SS	28	36x2	1		
			HD-WE-35L-NT-20	HD-WE-35L-NT-20-SS	35	45x2	1.1/4		
			HD-WE-42L-NT-24	HD-WE-42L-NT-24-SS	42	52x2	1.1/2		
			S	630	HD-WE-06S-NT-04	HD-WE-06S-NT-04-SS	6	14x1.5	1/4
					HD-WE-08S-NT-04	HD-WE-08S-NT-04-SS	8	16x1.5	1/4
	HD-WE-10S-NT-06	HD-WE-10S-NT-06-SS			10	18x1.5	3/8		
	HD-WE-12S-NT-06	HD-WE-12S-NT-06-SS			12	20x1.5	3/8		
	400	HD-WE-14S-NT-08		HD-WE-14S-NT-08-SS	14	22x1.5	1/2		
		HD-WE-16S-NT-08		HD-WE-16S-NT-08-SS	16	24x1.5	1/2		
		HD-WE-20S-NT-12	HD-WE-20S-NT-12-SS	20	30x2	3/4			
		HD-WE-25S-NT-16	HD-WE-25S-NT-16-SS	25	36x2	1			
	315	HD-WE-30S-NT-20	HD-WE-30S-NT-20-SS	30	42x2	1.1/4			
		HD-WE-38S-NT-24	HD-WE-38S-NT-24-SS	38	52x2	1.1/2			

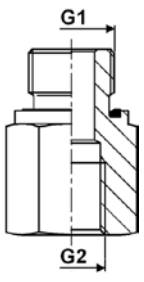
description	press. [bar]	code (galvanized steel)	code (AISI 316)	G1 [BSP]	G2 [BSP]	
BSP male connector with BSP female thread, DIN 3852-E seal  RI - BE	630	HD-RI-02-04-BE	HD-RI-02-04-BE-SS	1/8	1/4	
		HD-RI-04-02-BE	HD-RI-04-02-BE-SS	1/4	1/8	
		HD-RI-04-06-BE	HD-RI-04-06-BE-SS	1/4	3/8	
		HD-RI-04-08-BE	HD-RI-04-08-BE-SS	1/4	1/2	
		HD-RI-06-02-BE	HD-RI-06-02-BE-SS	3/8	1/8	
		HD-RI-06-04-BE	HD-RI-06-04-BE-SS	3/8	1/4	
		HD-RI-06-08-BE	HD-RI-06-08-BE-SS	3/8	1/2	
		HD-RI-08-04-BE	HD-RI-08-04-BE-SS	1/2	1/4	
		HD-RI-08-06-BE	HD-RI-08-06-BE-SS	1/2	3/8	
		400	HD-RI-08-12-BE	HD-RI-08-12-BE-SS	1/2	3/4
			HD-RI-12-06-BE	HD-RI-12-06-BE-SS	3/4	3/8
			HD-RI-12-08-BE	HD-RI-12-08-BE-SS	3/4	1/2
	HD-RI-12-16-BE		HD-RI-12-16-BE-SS	3/4	1	
	HD-RI-16-04-BE		HD-RI-16-04-BE-SS	1	1/4	
	HD-RI-16-06-BE		HD-RI-16-06-BE-SS	1	3/8	
	HD-RI-16-08-BE		HD-RI-16-08-BE-SS	1	1/2	
	HD-RI-16-12-BE		HD-RI-16-12-BE-SS	1	3/4	
	HD-RI-20-12-BE		HD-RI-20-12-BE-SS	1.1/4	3/4	
	HD-RI-20-16-BE		HD-RI-20-16-BE-SS	1.1/4	1	
	315		HD-RI-24-16-BE	HD-RI-24-16-BE-SS	1.1/2	1

HIGH PRESSURE - DIN 2353 connectors

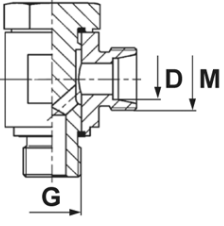
description	series	press. [bar]	code (galvanized steel)	code (AISI 316)	D [mm]	M [mm]	G [BSP]		
BANJO connector with BSP thread, DIN 3852-E seal  WH - BE	L	315	HD-WH-06L-BE-02	HD-WH-06L-BE-02-SS	6	12x1.5	1/8		
			HD-WH-08L-BE-04	HD-WH-08L-BE-04-SS	8	14x1.5	1/4		
			HD-WH-10L-BE-04	HD-WH-10L-BE-04-SS	10	16x1.5	1/4		
			HD-WH-12L-BE-06	HD-WH-12L-BE-06-SS	12	18x1.5	3/8		
			HD-WH-15L-BE-08	HD-WH-15L-BE-08-SS	15	22x1.5	1/2		
			HD-WH-18L-BE-08	HD-WH-18L-BE-08-SS	18	26x1.5	1/2		
		160	HD-WH-22L-BE-12	HD-WH-22L-BE-12-SS	22	30x2	3/4		
			HD-WH-28L-BE-16	HD-WH-28L-BE-16-SS	28	36x2	1		
			HD-WH-35L-BE-20	HD-WH-35L-BE-20-SS	35	45x2	1.1/4		
			HD-WH-42L-BE-24	HD-WH-42L-BE-24-SS	42	52x2	1.1/2		
			S	630	HD-WH-06S-BE-04	HD-WH-06S-BE-04-SS	6	14x1.5	1/4
					HD-WH-08S-BE-04	HD-WH-08S-BE-04-SS	8	16x1.5	1/4
	HD-WH-10S-BE-06	HD-WH-10S-BE-06-SS			10	18x1.5	3/8		
	400	HD-WH-12S-BE-06		HD-WH-12S-BE-06-SS	12	20x1.5	3/8		
		HD-WH-14S-BE-08		HD-WH-14S-BE-08-SS	14	22x1.5	1/2		
		HD-WH-16S-BE-08		HD-WH-16S-BE-08-SS	16	24x1.5	1/2		
	315	HD-WH-20S-BE-12	HD-WH-20S-BE-12-SS	20	30x2	3/4			
		HD-WH-25S-BE-16	HD-WH-25S-BE-16-SS	25	36x2	1			
		HD-WH-30S-BE-20	HD-WH-30S-BE-20-SS	30	42x2	1.1/4			
		HD-WH-38S-BE-24	HD-WH-38S-BE-24-SS	38	52x2	1.1/2			

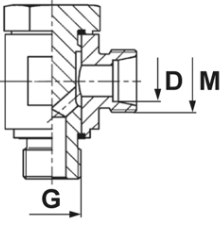
description	series	press. [bar]	code (galvanized steel)	code (AISI 316)	D [mm]	M [mm]	G [mm]		
BANJO connector with metric thread, DIN 3852-E seal  WH - ME	L	315	HD-WH-06L-ME-10	HD-WH-06L-ME-10-SS	6	12x1.5	10x1		
			HD-WH-08L-ME-12	HD-WH-08L-ME-12-SS	8	14x1.5	12x1.5		
			HD-WH-10L-ME-14	HD-WH-10L-ME-14-SS	10	16x1.5	14x1.5		
			HD-WH-12L-ME-16	HD-WH-12L-ME-16-SS	12	18x1.5	16x1.5		
			HD-WH-15L-ME-18	HD-WH-15L-ME-18-SS	15	22x1.5	18x1.5		
			HD-WH-18L-ME-22	HD-WH-18L-ME-22-SS	18	26x1.5	22x1.5		
		160	HD-WH-22L-ME-26	HD-WH-22L-ME-26-SS	22	30x2	26x1.5		
			HD-WH-28L-ME-33	HD-WH-28L-ME-33-SS	28	36x2	33x2		
			HD-WH-35L-ME-42	HD-WH-35L-ME-42-SS	35	45x2	42x2		
			HD-WH-42L-ME-48	HD-WH-42L-ME-48-SS	42	52x2	48x2		
			S	630	HD-WH-06S-ME-12	HD-WH-06S-ME-12-SS	6	14x1.5	12x1.5
					HD-WH-08S-ME-14	HD-WH-08S-ME-14-SS	8	16x1.5	14x1.5
	HD-WH-10S-ME-16	HD-WH-10S-ME-16-SS			10	18x1.5	16x1.5		
	400	HD-WH-12S-ME-18		HD-WH-12S-ME-18-SS	12	20x1.5	18x1.5		
		HD-WH-14S-ME-20		HD-WH-14S-ME-20-SS	14	22x1.5	20x1.5		
		HD-WH-16S-ME-22		HD-WH-16S-ME-22-SS	16	24x1.5	22x1.5		
	315	HD-WH-20S-ME-27	HD-WH-20S-ME-27-SS	20	30x2	27x2			
		HD-WH-25S-ME-33	HD-WH-25S-ME-33-SS	25	36x2	33x2			
		HD-WH-30S-ME-42	HD-WH-30S-ME-42-SS	30	42x2	42x2			
		HD-WH-38S-ME-48	HD-WH-38S-ME-48-SS	38	52x2	48x2			

HIGH PRESSURE - DIN 2353 connectors

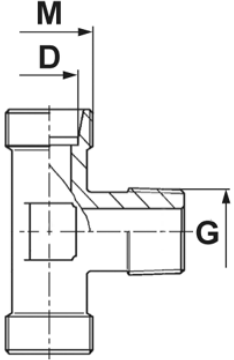
description	series	press. [bar]	code (galvanized steel)	code (AISI 316)	D [mm]	M [mm]	G [BSPT]		
Connector with BSPT tapered thread  TE - BT	L	315	HD-TE-06L-BT-02	HD-TE-06L-BT-02-SS	6	12x1.5	1/8		
			HD-TE-08L-BT-04	HD-TE-08L-BT-04-SS	8	14x1.5	1/4		
			HD-TE-10L-BT-04	HD-TE-10L-BT-04-SS	10	16x1.5	1/4		
			HD-TE-12L-BT-06	HD-TE-12L-BT-06-SS	12	18x1.5	3/8		
			HD-TE-15L-BT-08	HD-TE-15L-BT-08-SS	15	22x1.5	1/2		
			HD-TE-18L-BT-08	HD-TE-18L-BT-08-SS	18	26x1.5	1/2		
		160	HD-TE-22L-BT-12	HD-TE-22L-BT-12-SS	22	30x2	3/4		
			HD-TE-28L-BT-16	HD-TE-28L-BT-16-SS	28	36x2	1		
			HD-TE-35L-BT-20	HD-TE-35L-BT-20-SS	35	45x2	1.1/4		
			HD-TE-42L-BT-24	HD-TE-42L-BT-24-SS	42	52x2	1.1/2		
			S	630	HD-TE-06S-BT-04	HD-TE-06S-BT-04-SS	6	14x1.5	1/4
					HD-TE-08S-BT-04	HD-TE-08S-BT-04-SS	8	16x1.5	1/4
	HD-TE-10S-BT-06	HD-TE-10S-BT-06-SS			10	18x1.5	3/8		
	HD-TE-12S-BT-06	HD-TE-12S-BT-06-SS			12	20x1.5	3/8		
	HD-TE-14S-BT-08	HD-TE-14S-BT-08-SS			14	22x1.5	1/2		
	HD-TE-16S-BT-08	HD-TE-16S-BT-08-SS			16	24x1.5	1/2		
	400	HD-TE-20S-BT-12	HD-TE-20S-BT-12-SS	20	30x2	3/4			
		HD-TE-25S-BT-16	HD-TE-25S-BT-16-SS	25	36x2	1			
		HD-TE-30S-BT-20	HD-TE-30S-BT-20-SS	30	42x2	1.1/4			
		315	HD-TE-38S-BT-24	HD-TE-38S-BT-24-SS	38	52x2	1.1/2		

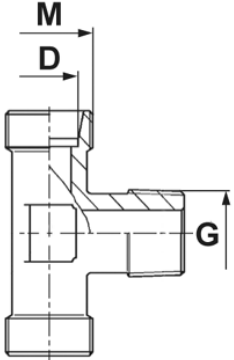
description	series	press. [bar]	code (galvanized steel)	code (AISI 316)	D [mm]	M [mm]	G [NPT]		
Connector with NPT tapered thread  TE - NT	L	315	HD-TE-06L-NT-02	HD-TE-06L-NT-02-SS	6	12x1.5	1/8		
			HD-TE-08L-NT-04	HD-TE-08L-NT-04-SS	8	14x1.5	1/4		
			HD-TE-10L-NT-04	HD-TE-10L-NT-04-SS	10	16x1.5	1/4		
			HD-TE-12L-NT-06	HD-TE-12L-NT-06-SS	12	18x1.5	3/8		
			HD-TE-15L-NT-08	HD-TE-15L-NT-08-SS	15	22x1.5	1/2		
			HD-TE-18L-NT-08	HD-TE-18L-NT-08-SS	18	26x1.5	1/2		
		160	HD-TE-22L-NT-12	HD-TE-22L-NT-12-SS	22	30x2	3/4		
			HD-TE-28L-NT-16	HD-TE-28L-NT-16-SS	28	36x2	1		
			HD-TE-35L-NT-20	HD-TE-35L-NT-20-SS	35	45x2	1.1/4		
			HD-TE-42L-NT-24	HD-TE-42L-NT-24-SS	42	52x2	1.1/2		
			S	630	HD-TE-06S-NT-04	HD-TE-06S-NT-04-SS	6	14x1.5	1/4
					HD-TE-08S-NT-04	HD-TE-08S-NT-04-SS	8	16x1.5	1/4
	HD-TE-10S-NT-06	HD-TE-10S-NT-06-SS			10	18x1.5	3/8		
	HD-TE-12S-NT-06	HD-TE-12S-NT-06-SS			12	20x1.5	3/8		
	HD-TE-14S-NT-08	HD-TE-14S-NT-08-SS			14	22x1.5	1/2		
	HD-TE-16S-NT-08	HD-TE-16S-NT-08-SS			16	24x1.5	1/2		
	400	HD-TE-20S-NT-12	HD-TE-20S-NT-12-SS	20	30x2	3/4			
		HD-TE-25S-NT-16	HD-TE-25S-NT-16-SS	25	36x2	1			
		HD-TE-30S-NT-20	HD-TE-30S-NT-20-SS	30	42x2	1.1/4			
		315	HD-TE-38S-NT-24	HD-TE-38S-NT-24-SS	38	52x2	1.1/2		

HIGH PRESSURE - DIN 2353 connectors

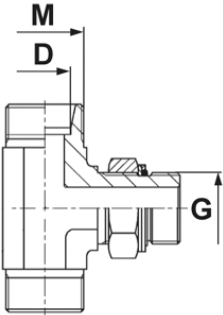
description	series	press. [bar]	code (galvanized steel)	code (AISI 316)	D [mm]	M [mm]	G [BSP]
Adjustable connector with BSP thread, ISO 1179-G seal  TE - BG	L	315	HD-TE-06L-BG-02	-	6	12x1.5	1/8
			HD-TE-08L-BG-04	-	8	14x1.5	1/4
			HD-TE-10L-BG-04	-	10	16x1.5	1/4
		250	HD-TE-12L-BG-06	-	12	18x1.5	3/8
			HD-TE-15L-BG-08	-	15	22x1.5	1/2
			HD-TE-18L-BG-08	-	18	26x1.5	1/2
			HD-TE-22L-BG-12	-	22	30x2	3/4
		160	HD-TE-28L-BG-16	-	28	36x2	1
			HD-TE-35L-BG-20	-	35	45x2	1.1/4
			HD-TE-42L-BG-24	-	42	52x2	1.1/2
	S	315	HD-TE-06S-BG-04	-	6	14x1.5	1/4
			HD-TE-08S-BG-04	-	8	16x1.5	1/4
		250	HD-TE-10S-BG-06	-	10	18x1.5	3/8
			HD-TE-12S-BG-06	-	12	20x1.5	3/8
			HD-TE-14S-BG-08	-	14	22x1.5	1/2
			HD-TE-16S-BG-08	-	16	24x1.5	1/2
		200	HD-TE-20S-BG-12	-	20	30x2	3/4
			HD-TE-25S-BG-16	-	25	36x2	1
		160	HD-TE-30S-BG-20	-	30	42x2	1.1/4
			HD-TE-38S-BG-24	-	38	52x2	1.1/2

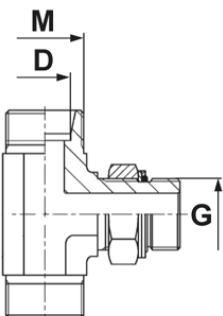
description	series	press. [bar]	code (galvanized steel)	code (AISI 316)	D [mm]	M [mm]	G [mm]
Adjustable connector with metric thread, ISO 6149-G seal  TE - MG	L	315	HD-TE-06L-MG-10	-	6	12x1.5	10x1
			HD-TE-08L-MG-12	-	8	14x1.5	12x1.5
			HD-TE-10L-MG-14	-	10	16x1.5	14x1.5
			HD-TE-12L-MG-16	-	12	18x1.5	16x1.5
			HD-TE-15L-MG-18	-	15	22x1.5	18x1.5
		250	HD-TE-18L-MG-22	-	18	26x1.5	22x1.5
			HD-TE-22L-MG-26	-	22	30x2	26x1.5
			HD-TE-28L-MG-33	-	28	36x2	33x2
			HD-TE-35L-MG-42	-	35	45x2	42x2
			HD-TE-42L-MG-48	-	42	52x2	48x2
	S	315	HD-TE-06S-MG-12	-	6	14x1.5	12x1.5
			HD-TE-08S-MG-14	-	8	16x1.5	14x1.5
			HD-TE-10S-MG-16	-	10	18x1.5	16x1.5
		250	HD-TE-12S-MG-18	-	12	20x1.5	18x1.5
			HD-TE-14S-MG-20	-	14	22x1.5	20x1.5
			HD-TE-16S-MG-22	-	16	24x1.5	22x1.5
			HD-TE-20S-MG-27	-	20	30x2	27x2
		160	HD-TE-25S-MG-33	-	25	36x2	33x2
			HD-TE-30S-MG-42	-	30	42x2	42x2
			HD-TE-38S-MG-48	-	38	52x2	48x2

HIGH PRESSURE - DIN 2353 connectors

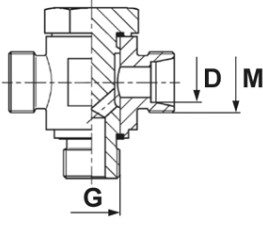
description	series	press. [bar]	code (galvanized steel)	code (AISI 316)	D [mm]	M [mm]	G [BSP]		
BANJO connector with BSP thread, DIN 3852-E seal  TH - BE	L	315	HD-TH-06L-BE-02	HD-TH-06L-BE-02-SS	6	12x1.5	1/8		
			HD-TH-08L-BE-04	HD-TH-08L-BE-04-SS	8	14x1.5	1/4		
			HD-TH-10L-BE-04	HD-TH-10L-BE-04-SS	10	16x1.5	1/4		
			HD-TH-12L-BE-06	HD-TH-12L-BE-06-SS	12	18x1.5	3/8		
			HD-TH-15L-BE-08	HD-TH-15L-BE-08-SS	15	22x1.5	1/2		
			HD-TH-18L-BE-08	HD-TH-18L-BE-08-SS	18	26x1.5	1/2		
		160	HD-TH-22L-BE-12	HD-TH-22L-BE-12-SS	22	30x2	3/4		
			HD-TH-28L-BE-16	HD-TH-28L-BE-16-SS	28	36x2	1		
			HD-TH-35L-BE-20	HD-TH-35L-BE-20-SS	35	45x2	1.1/4		
			HD-TH-42L-BE-24	HD-TH-42L-BE-24-SS	42	52x2	1.1/2		
			S	630	HD-TH-06S-BE-04	HD-TH-06S-BE-04-SS	6	14x1.5	1/4
					HD-TH-08S-BE-04	HD-TH-08S-BE-04-SS	8	16x1.5	1/4
	HD-TH-10S-BE-06	HD-TH-10S-BE-06-SS			10	18x1.5	3/8		
	HD-TH-12S-BE-06	HD-TH-12S-BE-06-SS			12	20x1.5	3/8		
	HD-TH-14S-BE-08	HD-TH-14S-BE-08-SS			14	22x1.5	1/2		
	400	HD-TH-16S-BE-08			HD-TH-16S-BE-08-SS	16	24x1.5	1/2	
		HD-TH-20S-BE-12	HD-TH-20S-BE-12-SS	20	30x2	3/4			
		HD-TH-25S-BE-16	HD-TH-25S-BE-16-SS	25	36x2	1			
		HD-TH-30S-BE-20	HD-TH-30S-BE-20-SS	30	42x2	1.1/4			
	315	HD-TH-38S-BE-24	HD-TH-38S-BE-24-SS	38	52x2	1.1/2			

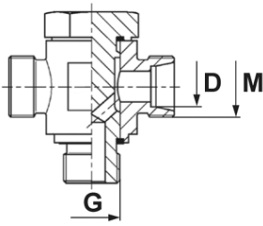
description	series	press. [bar]	code (galvanized steel)	code (AISI 316)	D [mm]	M [mm]	G [mm]		
BANJO connector with metric thread, DIN 3852-E seal  TH - ME	L	315	HD-TH-06L-ME-10	HD-TH-06L-ME-10-SS	6	12x1.5	10x1		
			HD-TH-08L-ME-12	HD-TH-08L-ME-12-SS	8	14x1.5	12x1.5		
			HD-TH-10L-ME-14	HD-TH-10L-ME-14-SS	10	16x1.5	14x1.5		
			HD-TH-12L-ME-16	HD-TH-12L-ME-16-SS	12	18x1.5	16x1.5		
			HD-TH-15L-ME-18	HD-TH-15L-ME-18-SS	15	22x1.5	18x1.5		
			HD-TH-18L-ME-22	HD-TH-18L-ME-22-SS	18	26x1.5	22x1.5		
		160	HD-TH-22L-ME-26	HD-TH-22L-ME-26-SS	22	30x2	26x1.5		
			HD-TH-28L-ME-33	HD-TH-28L-ME-33-SS	28	36x2	33x2		
			HD-TH-35L-ME-42	HD-TH-35L-ME-42-SS	35	45x2	42x2		
			HD-TH-42L-ME-48	HD-TH-42L-ME-48-SS	42	52x2	48x2		
			S	630	HD-TH-06S-ME-12	HD-TH-06S-ME-12-SS	6	14x1.5	12x1.5
					HD-TH-08S-ME-14	HD-TH-08S-ME-14-SS	8	16x1.5	14x1.5
	HD-TH-10S-ME-16	HD-TH-10S-ME-16-SS			10	18x1.5	16x1.5		
	HD-TH-12S-ME-18	HD-TH-12S-ME-18-SS			12	20x1.5	18x1.5		
	HD-TH-14S-ME-20	HD-TH-14S-ME-20-SS			14	22x1.5	20x1.5		
	400	HD-TH-16S-ME-22			HD-TH-16S-ME-22-SS	16	24x1.5	22x1.5	
		HD-TH-20S-ME-27	HD-TH-20S-ME-27-SS	20	30x2	27x2			
		HD-TH-25S-ME-33	HD-TH-25S-ME-33-SS	25	36x2	33x2			
		HD-TH-30S-ME-42	HD-TH-30S-ME-42-SS	30	42x2	42x2			
	315	HD-TH-38S-ME-48	HD-TH-38S-ME-48-SS	38	52x2	48x2			

HIGH PRESSURE - DIN 2353 connectors

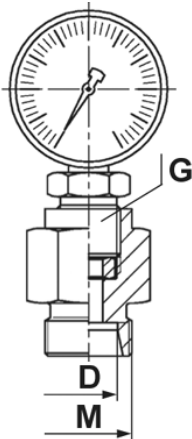
description	series	press. [bar]	code (galvanized steel)	code (AISI 316)	D [mm]	M [mm]	G [BSP]
Pressure gauge connector with BSP thread  MAV - B	L	315	HD-MAV-06L-B-04	HD-MAV-06L-B-04-SS	6	12x1.5	1/4
			HD-MAV-08L-B-04	HD-MAV-08L-B-04-SS	8	14x1.5	1/4
			HD-MAV-10L-B-04	HD-MAV-10L-B-04-SS	10	16x1.5	1/4
			HD-MAV-12L-B-04	HD-MAV-12L-B-04-SS	12	18x1.5	1/4
	S	630	HD-MAV-06S-B-08	HD-MAV-06S-B-08-SS	6	14x1.5	1/2
			HD-MAV-08S-B-08	HD-MAV-08S-B-08-SS	8	16x1.5	1/2
			HD-MAV-10S-B-08	HD-MAV-10S-B-08-SS	10	18x1.5	1/2
			HD-MAV-12S-B-08	HD-MAV-12S-B-08-SS	12	20x1.5	1/2

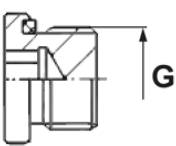
description	press. [bar]	code (galvanized steel)	code (AISI 316)	G [BSP]
Dust cap with BSP thread, DIN 3852-E seal  VSTI - BE	400	HD-VSTI-02-BE	HD-VSTI-02-BE-SS	1/8
		HD-VSTI-04-BE	HD-VSTI-04-BE-SS	1/4
		HD-VSTI-06-BE	HD-VSTI-06-BE-SS	3/8
		HD-VSTI-08-BE	HD-VSTI-08-BE-SS	1/2
		HD-VSTI-12-BE	HD-VSTI-12-BE-SS	3/4
		HD-VSTI-16-BE	HD-VSTI-16-BE-SS	1
	250	HD-VSTI-20-BE	HD-VSTI-20-BE-SS	1.1/4
		HD-VSTI-24-BE	HD-VSTI-24-BE-SS	1.1/2

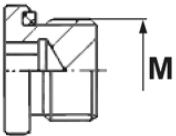
description	press. [bar]	code (galvanized steel)	code (AISI 316)	G [mm]
Dust cap with metric thread, DIN 3852-E seal  VSTI - ME	400	HD-VSTI-10-ME	HD-VSTI-10-ME-SS	10x1
		HD-VSTI-12-ME	HD-VSTI-12-ME-SS	12x1.5
		HD-VSTI-14-ME	HD-VSTI-14-ME-SS	14x1.5
		HD-VSTI-16-ME	HD-VSTI-16-ME-SS	16x1.5
		HD-VSTI-18-ME	HD-VSTI-18-ME-SS	18x1.5
		HD-VSTI-20-ME	HD-VSTI-20-ME-SS	20x1.5
		HD-VSTI-22-ME	HD-VSTI-22-ME-SS	22x1.5
		HD-VSTI-26-ME	HD-VSTI-26-ME-SS	26x1.5
		HD-VSTI-27-ME	HD-VSTI-27-ME-SS	27x2
		HD-VSTI-33-ME	HD-VSTI-33-ME-SS	33x2
	250	HD-VSTI-42-ME	HD-VSTI-42-ME-SS	42x2
		HD-VSTI-48-ME	HD-VSTI-48-ME-SS	48x2

HIGH PRESSURE - DIN 2353 connectors

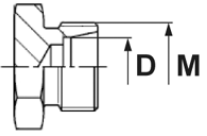
description	series	press. [bar]	code (galvanized steel)	code (AISI 316)	D [mm]	M [mm]
Dust cap  ROV	L	315	HD-ROV-06L	HD-ROV-06L-SS	6	12x1.5
			HD-ROV-08L	HD-ROV-08L-SS	8	14x1.5
			HD-ROV-10L	HD-ROV-10L-SS	10	16x1.5
			HD-ROV-12L	HD-ROV-12L-SS	12	18x1.5
			HD-ROV-15L	HD-ROV-15L-SS	15	22x1.5
			HD-ROV-18L	HD-ROV-18L-SS	18	26x1.5
		160	HD-ROV-22L	HD-ROV-22L-SS	22	30x2
			HD-ROV-28L	HD-ROV-28L-SS	28	36x2
			HD-ROV-35L	HD-ROV-35L-SS	35	45x2
			HD-ROV-42L	HD-ROV-42L-SS	42	52x2
	S	630	HD-ROV-06S	HD-ROV-06S-SS	6	14x1.5
			HD-ROV-08S	HD-ROV-08S-SS	8	16x1.5
			HD-ROV-10S	HD-ROV-10S-SS	10	18x1.5
			HD-ROV-12S	HD-ROV-12S-SS	12	20x1.5
			HD-ROV-14S	HD-ROV-14S-SS	14	22x1.5
		400	HD-ROV-16S	HD-ROV-16S-SS	16	24x1.5
			HD-ROV-20S	HD-ROV-20S-SS	20	30x2
			HD-ROV-25S	HD-ROV-25S-SS	25	36x2
			HD-ROV-30S	HD-ROV-30S-SS	30	42x2
			HD-ROV-38S	HD-ROV-38S-SS	38	52x2

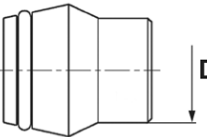
description	series	press. [bar]	code (galvanized steel)	code (AISI 316)	D [mm]
Plug  VKA	L/S	630	HD-VKA-06L-S	HD-VKA-06L-S-SS	6
			HD-VKA-08L-S	HD-VKA-08L-S-SS	8
			HD-VKA-10L-S	HD-VKA-10L-S-SS	10
			HD-VKA-12L-S	HD-VKA-12L-S-SS	12
	L	315	HD-VKA-15L	HD-VKA-15L-SS	15
			HD-VKA-18L	HD-VKA-18L-SS	18
		160	HD-VKA-22L	HD-VKA-22L-SS	22
			HD-VKA-28L	HD-VKA-28L-SS	28
			HD-VKA-35L	HD-VKA-35L-SS	35
			HD-VKA-42L	HD-VKA-42L-SS	42
	S	630	HD-VKA-14S	HD-VKA-14S-SS	14
			HD-VKA-16S	HD-VKA-16S-SS	16
		400	HD-VKA-20S	HD-VKA-20S-SS	20
			HD-VKA-25S	HD-VKA-25S-SS	25
			HD-VKA-30S	HD-VKA-30S-SS	30
			HD-VKA-38S	HD-VKA-38S-SS	38

HIGH PRESSURE - DIN 2353 connectors

Metric pipe connection system - Eaton Walterscheid™

DIN2353 Eaton Walterscheid™ connectors are designed for the most challenging applications of pipes connected and sealed on a 24° cone. Eaton Walterscheid™ system ensures tightness of the connection up to 800 bar (for heavy series) and 500 bar (for light series).

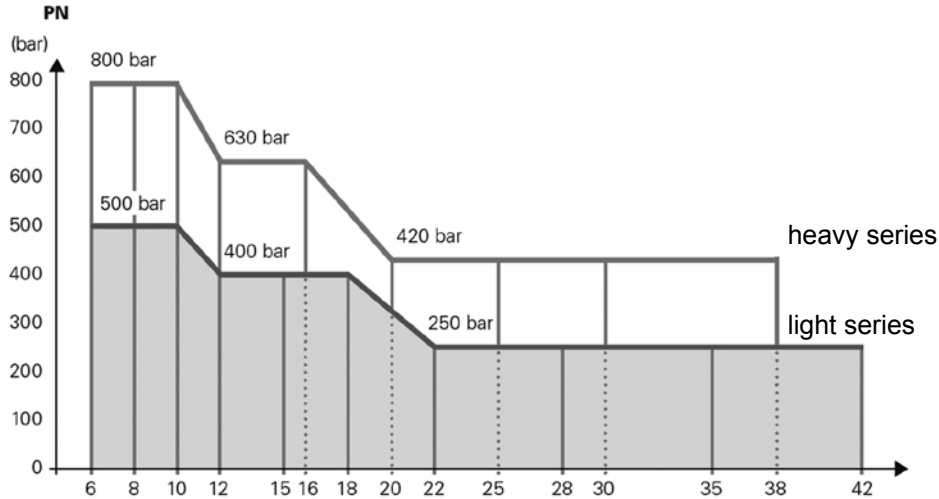

DIN2353 Eaton Walterscheid™ connectors made of carbon steel are plated with nickel-free, Guardian Seal™ cover to provide exceptional resistance to corrosion.

The corrosion resistance of Guardian Seal™ cover exceeds the German VDMA24576 K5 standard (min. 720 hours in a salt spray chamber until red corrosion appears), qualifying the connectors for operation in the most demanding and stringent conditions. Guardian Seal™ is relatively more environment friendly. The cover is free of nickel and solvents. It meets global requirements of such European directives as RoHS (Restriction of Hazardous Substances), ELV (End-of-Life Vehicle) and REACH (Regulation for Registration, Evaluation, Authorization and Restriction for Chemicals).

DIN2353 Eaton Walterscheid™ connector covered with corrosion resistant Guardian Seal™ is a popular solution in marine and offshore industry, for heavy duty application in agriculture, mining, railway and construction.



New Guardian Seal™ plating technology succeeds wherever standard protection fails!!!

HIGH PRESSURE - DIN 2353 connectors

Three options of Eaton Walterscheid™ system are available depending on the conditions of operation:

WalPro - static operation

A nut with a cutting ring. The profiled construction of the ring ensures optimal cut penetration and a clamp evenly distributed all around the pipe diameter. Sealing is achieved when the ring is pressed against 24° cone in a nut body during tightening. Available in stainless steel also. A complete system with a cutting ring and a nut is available only as a set marked with a code HDW-MWP...



WalRing - installation prone to vibration

A nut with a two-edge cutting ring integrated with a hardened, rubberized support ring with a special, elastomer (Viton) WALFORMplus seal. The support ring guarantees that the cutting ring properly penetrates a pipe. Reliable sealing is obtained when an elastomer seal is pressed between the pipe and the ring against 24° cone in a nut body during tightening. A complete WalRing system with rings, a seal and a nut is available only as a set marked with a code HDW-MWR...

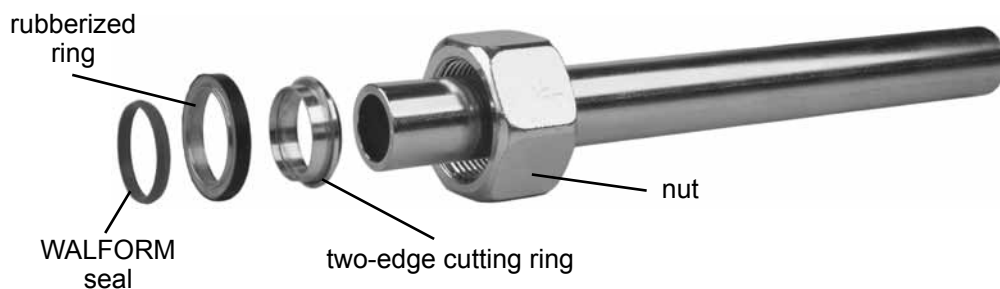

WALFORMplus - guarantees tightness even in highly dynamic operation conditions, pressure pulsation and mechanical loads

A nut with an elastomer (Viton) seal. For the system to work, the end of the pipe must be reshaped in a special machine intended for this purpose (available at TUBES INTERNATIONAL®). A shoulder formed on the pipe with the machine and the elastomer seal do not require any additional elements such as rings to make tight connection. Reliable sealing is obtained when an elastomer seal is pressed between the shoulder on the pipe and 24° cone in a nut body during tightening. The elements of WALFORMplus system (a seal and a nut) are available only as a set marked with a code HDW-MWF...

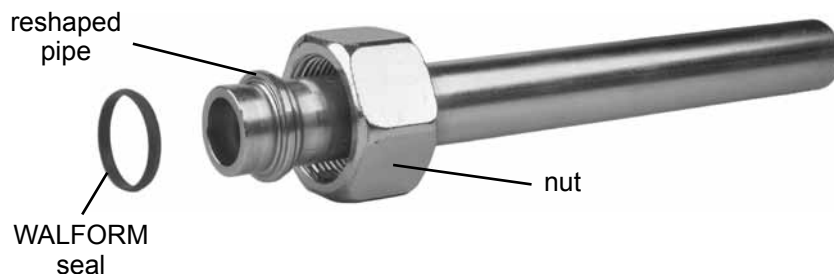

HIGH PRESSURE - DIN 2353 connectors

DIN 2353 Eaton Walterscheid™

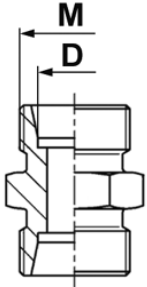
description	series	press. [bar]	code (galvanized steel)	D [mm]	M [mm]		
Straight connector  G	LL	100	HD-G-04LL-W	4	8x1		
			HD-G-06LL-W	6	10x1		
			HD-G-08LL-W	8	12x1		
	L	500	HD-G-06L-W	6	12x1.5		
			HD-G-08L-W	8	14x1.5		
			HD-G-10L-W	10	16x1.5		
		400	HD-G-12L-W	12	18x1.5		
			HD-G-15L-W	15	22x1.5		
			HD-G-18L-W	18	26x1.5		
		250	HD-G-22L-W	22	30x2		
			HD-G-28L-W	28	36x2		
			HD-G-35L-W	35	45x2		
			HD-G-42L-W	42	52x2		
			S	800	HD-G-06S-W	6	14x1.5
					HD-G-08S-W	8	16x1.5
	HD-G-10S-W	10			18x1.5		
	420	630	HD-G-12S-W	12	20x1.5		
			HD-G-16S-W	16	24x1.5		
			HD-G-20S-W	20	30x2		
		420	HD-G-25S-W	25	36x2		
			HD-G-30S-W	30	42x2		
	HD-G-38S-W	38	52x2				

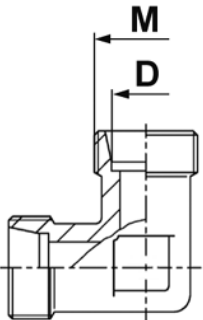
description	series	press. [bar]	code (galvanized steel)	D [mm]	M [mm]		
90° connector  W	LL	100	HD-W-04LL-W	4	8x1		
			HD-W-06LL-W	6	10x1		
			HD-W-08LL-W	8	12x1		
	L	500	HD-W-06L-W	6	12x1.5		
			HD-W-08L-W	8	14x1.5		
			HD-W-10L-W	10	16x1.5		
		400	HD-W-12L-W	12	18x1.5		
			HD-W-15L-W	15	22x1.5		
			HD-W-18L-W	18	26x1.5		
		250	HD-W-22L-W	22	30x2		
			HD-W-28L-W	28	36x2		
			HD-W-35L-W	35	45x2		
			HD-W-42L-W	42	52x2		
			S	800	HD-W-06S-W	6	14x1.5
					HD-W-08S-W	8	16x1.5
	HD-W-10S-W	10			18x1.5		
	420	630	HD-W-12S-W	12	20x1.5		
			HD-W-16S-W	16	24x1.5		
			HD-W-20S-W	20	30x2		
		420	HD-W-25S-W	25	36x2		
			HD-W-30S-W	30	42x2		
	HD-W-38S-W	38	52x2				

HIGH PRESSURE - DIN 2353 connectors

DIN 2353 Eaton Walterscheid™

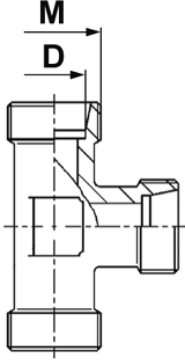
description	series	press. [bar]	code (galvanized steel)	D [mm]	M [mm]		
 <p>T</p>	LL	100	HD-T-04LL-W	4	8x1		
			HD-T-06LL-W	6	10x1		
			HD-T-08LL-W	8	12x1		
	L	500	500	HD-T-06L-W	6	12x1.5	
				HD-T-08L-W	8	14x1.5	
				HD-T-10L-W	10	16x1.5	
		400	400	HD-T-12L-W	12	18x1.5	
				HD-T-15L-W	15	22x1.5	
				HD-T-18L-W	18	26x1.5	
		250	250	HD-T-22L-W	22	30x2	
				HD-T-28L-W	28	36x2	
				HD-T-35L-W	35	45x2	
		S	800	800	HD-T-42L-W	42	52x2
					HD-T-06S-W	6	14x1.5
					HD-T-08S-W	8	16x1.5
			630	630	HD-T-10S-W	10	18x1.5
					HD-T-12S-W	12	20x1.5
					HD-T-14S-W	14	22x1.5
	420		420	HD-T-16S-W	16	24x1.5	
				HD-T-20S-W	20	30x2	
				HD-T-25S-W	25	36x2	
400	400	HD-T-30S-W	30	42x2			
400	400	HD-T-38S-W	38	52x2			

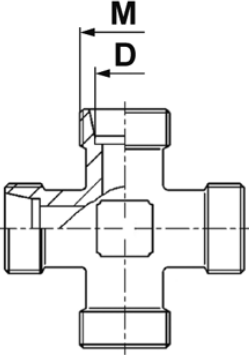
description	series	press. [bar]	code (galvanized steel)	D [mm]	M [mm]		
 <p>K</p>	LL	100	HD-K-04LL-W	4	8x1		
			HD-K-06LL-W	6	10x1		
			HD-K-08LL-W	8	12x1		
	L	500	500	HD-K-06L-W	6	12x1.5	
				HD-K-08L-W	8	14x1.5	
				HD-K-10L-W	10	16x1.5	
		400	400	HD-K-12L-W	12	18x1.5	
				HD-K-15L-W	15	22x1.5	
				HD-K-18L-W	18	26x1.5	
		250	250	HD-K-22L-W	22	30x2	
				HD-K-28L-W	28	36x2	
				HD-K-35L-W	35	45x2	
		S	800	800	HD-K-42L-W	42	52x2
					HD-K-06S-W	6	14x1.5
					HD-K-08S-W	8	16x1.5
			630	630	HD-K-10S-W	10	18x1.5
					HD-K-12S-W	12	20x1.5
					HD-K-16S-W	16	24x1.5
	420		420	HD-K-20S-W	20	30x2	
				HD-K-25S-W	25	36x2	
				HD-K-30S-W	30	42x2	
400	400	HD-K-38S-W	38	52x2			

HIGH PRESSURE - DIN 2353 connectors

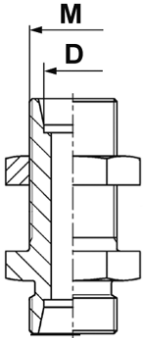
description	series	press. [bar]	code (galvanized steel)	D [mm]	M [mm]
Straight bulkhead connector  SV	L	500	HD-SV-06L-W	6	12x1.5
			HD-SV-08L-W	8	14x1.5
			HD-SV-10L-W	10	16x1.5
		400	HD-SV-12L-W	12	18x1.5
			HD-SV-15L-W	15	22x1.5
			HD-SV-18L-W	18	26x1.5
		250	HD-SV-22L-W	22	30x2
			HD-SV-28L-W	28	36x2
			HD-SV-35L-W	35	45x2
	S	800	HD-SV-42L-W	42	52x2
			HD-SV-06S-W	6	14x1.5
			HD-SV-08S-W	8	16x1.5
		630	HD-SV-10S-W	10	18x1.5
			HD-SV-12S-W	12	20x1.5
			HD-SV-16S-W	16	24x1.5
		400	HD-SV-20S-W	20	30x2
			HD-SV-25S-W	25	36x2
			HD-SV-30S-W	30	42x2
HD-SV-38S-W	38	52x2			

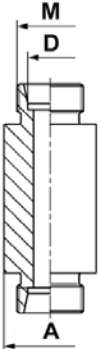
description	series	press. [bar]	code (black steel)	D [mm]	M [mm]
Straight bulkhead connector with weld-in ends  ESV	L	500	HD-ESV-06L-W	6	12x1.5
			HD-ESV-08L-W	8	14x1.5
			HD-ESV-10L-W	10	16x1.5
		400	HD-ESV-12L-W	12	18x1.5
			HD-ESV-15L-W	15	22x1.5
			HD-ESV-18L-W	18	26x1.5
		250	HD-ESV-22L-W	22	30x2
			HD-ESV-28L-W	28	36x2
			HD-ESV-35L-W	35	45x2
	S	800	HD-ESV-42L-W	42	52x2
			HD-ESV-06S-W	6	14x1.5
			HD-ESV-08S-W	8	16x1.5
		630	HD-ESV-10S-W	10	18x1.5
			HD-ESV-12S-W	12	20x1.5
			HD-ESV-16S-W	16	24x1.5
		420	HD-ESV-20S-W	20	30x2
			HD-ESV-25S-W	25	36x2
			HD-ESV-30S-W	30	42x2
HD-ESV-38S-W	38	52x2			

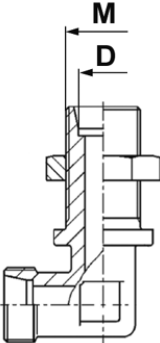
description	series	press. [bar]	code (galvanized steel)	D [mm]	M [mm]
90° bulkhead connector  WSV	L	500	HD-WSV-06L-W	6	12x1.5
			HD-WSV-08L-W	8	14x1.5
			HD-WSV-10L-W	10	16x1.5
		400	HD-WSV-12L-W	12	18x1.5
			HD-WSV-15L-W	15	22x1.5
			HD-WSV-18L-W	18	26x1.5
		250	HD-WSV-22L-W	22	30x2
			HD-WSV-28L-W	28	36x2
			HD-WSV-35L-W	35	45x2
	S	800	HD-WSV-42L-W	42	52x2
			HD-WSV-06S-W	6	14x1.5
			HD-WSV-08S-W	8	16x1.5
		630	HD-WSV-10S-W	10	18x1.5
			HD-WSV-12S-W	12	20x1.5
			HD-WSV-16S-W	16	24x1.5
		400	HD-WSV-20S-W	20	30x2
			HD-WSV-25S-W	25	36x2
			HD-WSV-30S-W	30	42x2
HD-WSV-38S-W	38	52x2			

HIGH PRESSURE - DIN 2353 connectors

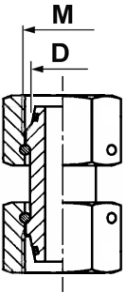
description	series	press. [bar]	code (galvanized steel)	D [mm]	M [mm]
Adjustable connector  SNV	L	500	HD-SNV-06L-W	6	12x1.5
			HD-SNV-08L-W	8	14x1.5
			HD-SNV-10L-W	10	16x1.5
		400	HD-SNV-12L-W	12	18x1.5
			HD-SNV-15L-W	15	22x1.5
			HD-SNV-18L-W	18	26x1.5
		250	HD-SNV-22L-W	22	30x2
			HD-SNV-28L-W	28	36x2
			HD-SNV-35L-W	35	45x2
	S	800	HD-SNV-42L-W	42	52x2
			HD-SNV-06S-W	6	14x1.5
			HD-SNV-08S-W	8	16x1.5
		630	HD-SNV-10S-W	10	18x1.5
			HD-SNV-12S-W	12	20x1.5
			HD-SNV-16S-W	16	24x1.5
		420	HD-SNV-20S-W	20	30x2
			HD-SNV-25S-W	25	36x2
			HD-SNV-30S-W	30	42x2
400	HD-SNV-38S-W	38	52x2		

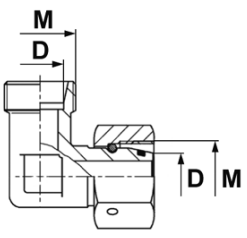
description	series	press. [bar]	code (galvanized steel)	D [mm]	M [mm]
Adjustable 90° connector, O-ring seal  EVWO	L	500	HD-EVWO-06L-W	6	12x1.5
			HD-EVWO-08L-W	8	14x1.5
			HD-EVWO-10L-W	10	16x1.5
		400	HD-EVWO-12L-W	12	18x1.5
			HD-EVWO-15L-W	15	22x1.5
			HD-EVWO-18L-W	18	26x1.5
		250	HD-EVWO-22L-W	22	30x2
			HD-EVWO-28L-W	28	36x2
			HD-EVWO-35L-W	35	45x2
	S	800	HD-EVWO-42L-W	42	52x2
			HD-EVWO-06S-W	6	14x1.5
			HD-EVWO-08S-W	8	16x1.5
		630	HD-EVWO-10S-W	10	18x1.5
			HD-EVWO-12S-W	12	20x1.5
			HD-EVWO-16S-W	16	24x1.5
		420	HD-EVWO-20S-W	20	30x2
			HD-EVWO-25S-W	25	36x2
			HD-EVWO-30S-W	30	42x2
	400	HD-EVWO-38S-W	38	52x2	

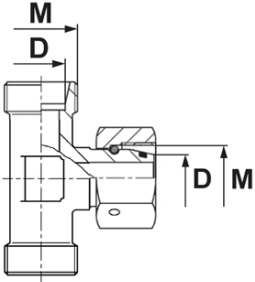
description	series	press. [bar]	code (galvanized steel)	D [mm]	M [mm]
Tee connector, O-ring seal  EVTO	L	500	HD-EVTO-06L-W	6	12x1.5
			HD-EVTO-08L-W	8	14x1.5
			HD-EVTO-10L-W	10	16x1.5
		400	HD-EVTO-12L-W	12	18x1.5
			HD-EVTO-15L-W	15	22x1.5
			HD-EVTO-18L-W	18	26x1.5
		250	HD-EVTO-22L-W	22	30x2
			HD-EVTO-28L-W	28	36x2
			HD-EVTO-35L-W	35	45x2
	S	800	HD-EVTO-42L-W	42	52x2
			HD-EVTO-06S-W	6	14x1.5
			HD-EVTO-08S-W	8	16x1.5
		630	HD-EVTO-10S-W	10	18x1.5
			HD-EVTO-12S-W	12	20x1.5
			HD-EVTO-16S-W	16	24x1.5
		420	HD-EVTO-20S-W	20	30x2
			HD-EVTO-25S-W	25	36x2
			HD-EVTO-30S-W	30	42x2
400	HD-EVTO-38S-W	38	52x2		

HIGH PRESSURE - DIN 2353 connectors

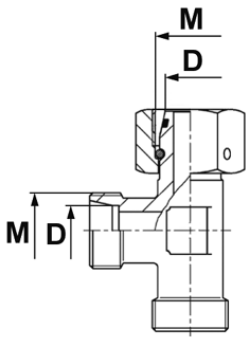
description	series	press. [bar]	code (galvanized steel)	D [mm]	M [mm]
Adjustable connector (lateral), O-ring seal  EVLO	L	500	HD-EVLO-06L-W	6	12x1.5
			HD-EVLO-08L-W	8	14x1.5
			HD-EVLO-10L-W	10	16x1.5
		400	HD-EVLO-12L-W	12	18x1.5
			HD-EVLO-15L-W	15	22x1.5
			HD-EVLO-18L-W	18	26x1.5
			HD-EVLO-22L-W	22	30x2
			HD-EVLO-28L-W	28	36x2
			HD-EVLO-35L-W	35	45x2
			HD-EVLO-42L-W	42	52x2
	S	800	HD-EVLO-06S-W	6	14x1.5
			HD-EVLO-08S-W	8	16x1.5
			HD-EVLO-10S-W	10	18x1.5
		630	HD-EVLO-12S-W	12	20x1.5
			HD-EVLO-16S-W	16	24x1.5
		420	HD-EVLO-20S-W	20	30x2
			HD-EVLO-25S-W	25	36x2
			HD-EVLO-30S-W	30	42x2
		400	HD-EVLO-38S-W	38	52x2

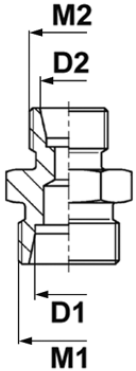
description	series	press. [bar]	code (galvanized steel)	D1 [mm]	M1 [mm]	D2 [mm]	M2 [mm]		
Straight reducing connector  GR	LL	100	HD-GR-06-04LL-W	6	10x1	4	8x1		
			HD-GR-08-04LL-W	8	12x1	4	8x1		
	L	500	HD-GR-08-06L-W	8	14x1.5	6	12x1.5		
			HD-GR-10-06L-W	10	16x1.5	6	12x1.5		
			HD-GR-10-08L-W	10	16x1.5	8	14x1.5		
			HD-GR-12-06L-W	12	18x1.5	6	12x1.5		
			HD-GR-12-08L-W	12	18x1.5	8	14x1.5		
			HD-GR-12-10L-W	12	18x1.5	10	16x1.5		
		400	HD-GR-15-10L-W	15	22x1.5	10	16x1.5		
			HD-GR-15-12L-W	15	22x1.5	12	18x1.5		
			HD-GR-18-10L-W	18	26x1.5	10	16x1.5		
			HD-GR-18-12L-W	18	26x1.5	12	18x1.5		
			HD-GR-18-15L-W	18	26x1.5	15	22x1.5		
			HD-GR-22-15L-W	22	30x2	15	22x1.5		
			HD-GR-22-18L-W	22	30x2	18	26x1.5		
			HD-GR-28-22L-W	28	36x2	22	30x2		
			S	630	HD-GR-16-12S-W	16	24x1.5	12	20x1.5
					HD-GR-20-16S-W	20	30x2	16	24x1.5
			420	HD-GR-25-16S-W	25	36x2	16	24x1.5	
				HD-GR-25-20S-W	25	36x2	20	30x2	

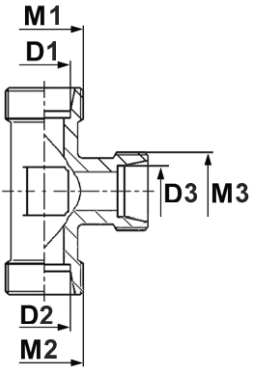
description	series	press. [bar]	code (galvanized steel)	D1 [mm]	M1 [mm]	D2 [mm]	M2 [mm]	D3 [mm]	M3 [mm]
Tee reducing connector  TR	L	500	HD-TR-10-10-06L-W	10	16x1.5	10	16x1.5	6	12x1.5
			HD-TR-10-10-08L-W	10	16x1.5	10	16x1.5	8	14x1.5
		400	HD-TR-12-12-06L-W	12	18x1.5	12	18x1.5	6	12x1.5
			HD-TR-12-12-08L-W	12	18x1.5	12	18x1.5	8	14x1.5
			HD-TR-12-12-10L-W	12	18x1.5	12	18x1.5	10	16x1.5
			HD-TR-12-12-15L-W	12	18x1.5	12	18x1.5	15	22x1.5
			HD-TR-15-12-12L-W	15	22x1.5	12	18x1.5	12	18x1.5
			HD-TR-15-12-15L-W	15	22x1.5	12	18x1.5	15	22x1.5
			HD-TR-15-15-08L-W	15	22x1.5	15	22x1.5	8	14x1.5
			HD-TR-15-15-10L-W	15	22x1.5	15	22x1.5	10	16x1.5
	HD-TR-15-15-12L-W	15	22x1.5	15	22x1.5	12	18x1.5		
	HD-TR-18-12-12L-W	18	26x1.5	12	18x1.5	12	18x1.5		
	HD-TR-18-18-10L-W	18	26x1.5	18	26x1.5	10	16x1.5		
	HD-TR-18-18-12L-W	18	26x1.5	18	26x1.5	12	18x1.5		
	HD-TR-18-18-15L-W	18	26x1.5	18	26x1.5	15	22x1.5		
	250	HD-TR-22-22-10L-W	22	30x2	22	30x2	10	16x1.5	
		HD-TR-22-22-15L-W	22	30x2	22	30x2	15	22x1.5	
		HD-TR-28-22-22L-W	28	36x2	22	30x2	22	30x2	
		HD-TR-28-28-22L-W	28	36x2	28	36x2	22	30x2	

HIGH PRESSURE - DIN 2353 connectors

DIN 2353 Eaton Walterscheid™

description	series	press. [bar]	code (galvanized steel)	D1 [mm]	M1 [mm]	D2 [mm]	M2 [mm]	
Straight reducing connector	L	500	HD-KORO-08-06L-W	8	14x1.5	6	12x1.5	
			HD-KORO-10-06L-W	10	16x1.5	6	12x1.5	
			HD-KORO-10-08L-W	10	16x1.5	8	14x1.5	
		400	HD-KORO-12-06L-W	12	18x1.5	6	12x1.5	
			HD-KORO-12-08L-W	12	18x1.5	8	14x1.5	
			HD-KORO-12-10L-W	12	18x1.5	10	16x1.5	
			HD-KORO-15-06L-W	15	22x1.5	6	12x1.5	
			HD-KORO-15-08L-W	15	22x1.5	8	14x1.5	
			HD-KORO-15-10L-W	15	22x1.5	10	16x1.5	
			HD-KORO-15-12L-W	15	22x1.5	12	18x1.5	
			HD-KORO-18-06L-W	18	26x1.5	6	12x1.5	
			HD-KORO-18-08L-W	18	26x1.5	8	14x1.5	
			HD-KORO-18-10L-W	18	26x1.5	10	16x1.5	
			HD-KORO-18-12L-W	18	26x1.5	12	18x1.5	
			HD-KORO-18-15L-W	18	26x1.5	15	22x1.5	
			250	HD-KORO-22-06L-W	22	30x2	6	12x1.5
				HD-KORO-22-08L-W	22	30x2	8	14x1.5
				HD-KORO-22-10L-W	22	30x2	10	16x1.5
		HD-KORO-22-12L-W		22	30x2	12	18x1.5	
		HD-KORO-22-15L-W		22	30x2	15	22x1.5	
		HD-KORO-22-18L-W		22	30x2	18	26x1.5	
		HD-KORO-28-06L-W		28	36x2	6	12x1.5	
		HD-KORO-28-08L-W		28	36x2	8	14x1.5	
		HD-KORO-28-10L-W		28	36x2	10	16x1.5	
		HD-KORO-28-12L-W		28	36x2	12	18x1.5	
		HD-KORO-28-15L-W		28	36x2	15	22x1.5	
		HD-KORO-28-18L-W		28	36x2	18	26x1.5	
		HD-KORO-28-22L-W		28	36x2	22	30x2	
		HD-KORO-35-06L-W		35	45x2	6	12x1.5	
		HD-KORO-35-08L-W		35	45x2	8	14x1.5	
		HD-KORO-35-10L-W		35	45x2	10	16x1.5	
		HD-KORO-35-12L-W		35	45x2	12	18x1.5	
		HD-KORO-35-15L-W		35	45x2	15	22x1.5	
		HD-KORO-35-18L-W		35	45x2	18	26x1.5	
		HD-KORO-35-22L-W		35	45x2	22	30x2	
		HD-KORO-35-28L-W		35	45x2	28	36x2	
		HD-KORO-42-06L-W	42	52x2	6	12x1.5		
		HD-KORO-42-08L-W	42	52x2	8	14x1.5		
		HD-KORO-42-10L-W	42	52x2	10	16x1.5		
		HD-KORO-42-12L-W	42	52x2	12	18x1.5		
		HD-KORO-42-15L-W	42	52x2	15	22x1.5		
		HD-KORO-42-18L-W	42	52x2	18	26x1.5		
HD-KORO-42-22L-W	42	52x2	22	30x2				
HD-KORO-42-28L-W	42	52x2	28	36x2				
HD-KORO-42-35L-W	42	52x2	35	45x2				

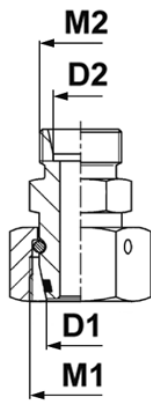

KORO - L

HIGH PRESSURE - DIN 2353 connectors

DIN 2353 Eaton Walterscheid™

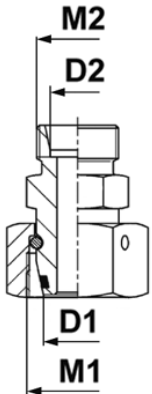
description	series	press. [bar]	code (galvanized steel)	D1 [mm]	M1 [mm]	D2 [mm]	M2 [mm]
Straight reducing connector 	S	800	HD-KORO-08-06S-W	8	16x1.5	6	14x1.5
			HD-KORO-10-06S-W	10	18x1.5	6	14x1.5
			HD-KORO-10-08S-W	10	18x1.5	8	16x1.5
		630	HD-KORO-12-06S-W	12	20x1.5	6	14x1.5
			HD-KORO-12-08S-W	12	20x1.5	8	16x1.5
			HD-KORO-12-10S-W	12	20x1.5	10	18x1.5
			HD-KORO-16-06S-W	16	24x1.5	6	14x1.5
			HD-KORO-16-08S-W	16	24x1.5	8	16x1.5
			HD-KORO-16-10S-W	16	24x1.5	10	18x1.5
			HD-KORO-16-12S-W	16	24x1.5	12	20x1.5
		420	HD-KORO-16-14S-W	16	24x1.5	14	22x1.5
			HD-KORO-20-06S-W	20	30x2	6	14x1.5
			HD-KORO-20-08S-W	20	30x2	8	16x1.5
			HD-KORO-20-10S-W	20	30x2	10	18x1.5
			HD-KORO-20-12S-W	20	30x2	12	20x1.5
			HD-KORO-20-14S-W	20	30x2	14	22x1.5
			HD-KORO-20-16S-W	20	30x2	16	24x1.5
			HD-KORO-25-06S-W	25	36x2	6	14x1.5
			HD-KORO-25-08S-W	25	36x2	8	16x1.5
			HD-KORO-25-10S-W	25	36x2	10	18x1.5
			HD-KORO-25-12S-W	25	36x2	12	20x1.5
			HD-KORO-25-16S-W	25	36x2	16	24x1.5
		400	HD-KORO-25-20S-W	25	36x2	20	30x2
			HD-KORO-30-06S-W	30	42x2	6	14x1.5
			HD-KORO-30-08S-W	30	42x2	8	16x1.5
			HD-KORO-30-10S-W	30	42x2	10	18x1.5
			HD-KORO-30-12S-W	30	42x2	12	20x1.5
			HD-KORO-30-16S-W	30	42x2	16	24x1.5
			HD-KORO-30-20S-W	30	42x2	20	30x2
			HD-KORO-30-25S-W	30	42x2	25	36x2
			HD-KORO-38-06S-W	38	52x2	6	14x1.5
			HD-KORO-38-08S-W	38	52x2	8	16x1.5
			HD-KORO-38-10S-W	38	52x2	10	18x1.5
			HD-KORO-38-12S-W	38	52x2	12	20x1.5
			HD-KORO-38-16S-W	38	52x2	16	24x1.5
		HD-KORO-38-20S-W	38	52x2	20	30x2	
		HD-KORO-38-25S-W	38	52x2	25	36x2	
		HD-KORO-38-30S-W	38	52x2	30	42x2	

KORO - S

HIGH PRESSURE - DIN 2353 connectors

DIN 2353 Eaton Walterscheid™

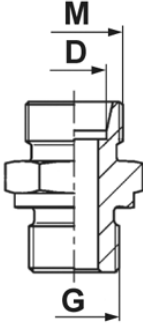
description	series	press. [bar]	code (galvanized steel)	D [mm]	M [mm]	G [BSP]	
Straight connector with BSP thread, DIN 3852-B seal 	LL	100	HD-GE-04LL-BB-02-W	4	8x1	1/8	
			HD-GE-06LL-BB-02-W	6	10x1	1/8	
			HD-GE-08LL-BB-02-W	8	12x1	1/8	
	L	400	HD-GE-06L-BB-02-W	6	12x1.5	1/8	
			HD-GE-06L-BB-04-W	6	12x1.5	1/4	
			HD-GE-06L-BB-06-W	6	12x1.5	3/8	
			HD-GE-08L-BB-02-W	8	14x1.5	1/8	
			HD-GE-08L-BB-04-W	8	14x1.5	1/4	
			HD-GE-08L-BB-06-W	8	14x1.5	3/8	
			HD-GE-08L-BB-08-W	8	14x1.5	1/2	
			HD-GE-10L-BB-04-W	10	16x1.5	1/4	
			HD-GE-10L-BB-06-W	10	16x1.5	3/8	
			HD-GE-10L-BB-08-W	10	16x1.5	1/2	
			HD-GE-12L-BB-04-W	12	18x1.5	1/4	
			HD-GE-12L-BB-06-W	12	18x1.5	3/8	
			HD-GE-12L-BB-08-W	12	18x1.5	1/2	
			HD-GE-15L-BB-06-W	15	22x1.5	3/8	
			HD-GE-15L-BB-08-W	15	22x1.5	1/2	
			HD-GE-15L-BB-12-W	15	22x1.5	3/4	
			HD-GE-18L-BB-08-W	18	26x1.5	1/2	
			HD-GE-18L-BB-12-W	18	26x1.5	3/4	
			250	HD-GE-22L-BB-08-W	22	30x2	1/2
				HD-GE-22L-BB-12-W	22	30x2	3/4
				HD-GE-28L-BB-12-W	28	36x2	3/4
	HD-GE-28L-BB-16-W	28		36x2	1		
	HD-GE-35L-BB-20-W	35		45x2	1.1/4		
	HD-GE-42L-BB-24-W	42		52x2	1.1/2		
	S	630	HD-GE-06S-BB-04-W	6	14x1.5	1/4	
			HD-GE-08S-BB-04-W	8	16x1.5	1/4	
			HD-GE-08S-BB-06-W	8	16x1.5	3/8	
			HD-GE-10S-BB-04-W	10	18x1.5	1/4	
			HD-GE-10S-BB-06-W	10	18x1.5	3/8	
			HD-GE-10S-BB-08-W	10	18x1.5	1/2	
			HD-GE-12S-BB-04-W	12	20x1.5	1/4	
			HD-GE-12S-BB-06-W	12	20x1.5	3/8	
			HD-GE-12S-BB-08-W	12	20x1.5	1/2	
			HD-GE-16S-BB-06-W	16	24x1.5	3/8	
			HD-GE-16S-BB-08-W	16	24x1.5	1/2	
			HD-GE-16S-BB-12-W	16	24x1.5	3/4	
		400	HD-GE-20S-BB-08-W	20	30x2	1/2	
			HD-GE-20S-BB-12-W	20	30x2	3/4	
			HD-GE-25S-BB-12-W	25	36x2	3/4	
			HD-GE-25S-BB-16-W	25	36x2	1	
			250	HD-GE-30S-BB-20-W	30	42x2	1.1/4
				HD-GE-38S-BB-20-W	38	52x2	1.1/4
HD-GE-38S-BB-24-W	38	52x2	1.1/2				

GE - BB

description	series	press. [bar]	code (galvanized steel)	D [mm]	M [mm]	G [BSPT]
Straight connector with BSPT tapered thread 	LL	100	HD-GE-04LL-BT-02-W	4	8x1	1/8
			HD-GE-06LL-BT-02-W	6	10x1	1/8
			HD-GE-08LL-BT-02-W	8	12x1	1/8
	L	250	HD-GE-06L-BT-04-W	6	12x1.5	1/4
			HD-GE-08L-BT-04-W	8	14x1.5	1/4
			HD-GE-08L-BT-06-W	8	14x1.5	3/8
			HD-GE-10L-BT-04-W	10	16x1.5	1/4
			HD-GE-10L-BT-06-W	10	16x1.5	3/8
			HD-GE-12L-BT-04-W	12	18x1.5	1/4
			HD-GE-12L-BT-06-W	12	18x1.5	3/8
			HD-GE-12L-BT-08-W	12	18x1.5	1/2
			HD-GE-15L-BT-08-W	15	22x1.5	1/2

GE - BT

HIGH PRESSURE - DIN 2353 connectors

DIN 2353 Eaton Walterscheid™

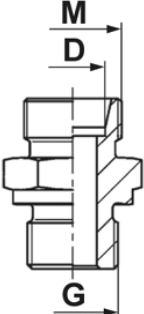
description	series	press. [bar]	code (galvanized steel)	D [mm]	M [mm]	G [mm]		
Straight connector with metric thread, DIN 3852-B seal 	LL	100	HD-GE-04LL-MB-08-W	4	8x1	8x1		
			HD-GE-06LL-MB-10-W	6	10x1	10x1		
			HD-GE-08LL-MB-10-W	8	12x1	10x1		
	L	400	HD-GE-06L-MB-10-W	6	12x1.5	10x1		
			HD-GE-06L-MB-12-W	6	12x1.5	12x1.5		
			HD-GE-08L-MB-12-W	8	14x1.5	12x1.5		
			HD-GE-08L-MB-18-W	8	14x1.5	18x1.5		
			HD-GE-10L-MB-14-W	10	16x1.5	14x1.5		
			HD-GE-10L-MB-16-W	10	16x1.5	16x1.5		
			HD-GE-10L-MB-18-W	10	16x1.5	18x1.5		
			HD-GE-10L-MB-22-W	10	16x1.5	22x1.5		
			HD-GE-12L-MB-16-W	12	18x1.5	16x1.5		
			HD-GE-12L-MB-18-W	12	18x1.5	18x1.5		
			HD-GE-12L-MB-22-W	12	18x1.5	22x1.5		
			HD-GE-15L-MB-18-W	15	22x1.5	18x1.5		
			HD-GE-15L-MB-22-W	15	22x1.5	22x1.5		
			HD-GE-18L-MB-18-W	18	26x1.5	18x1.5		
			HD-GE-18L-MB-22-W	18	26x1.5	22x1.5		
			S	250	HD-GE-22L-MB-26-W	22	30x2	26x1.5
					HD-GE-28L-MB-33-W	28	36x2	33x2
					HD-GE-35L-MB-42-W	35	45x2	42x2
	HD-GE-42L-MB-48-W	42			52x2	48x2		
	HD-GE-06S-MB-12-W	6			14x1.5	12x1.5		
	HD-GE-08S-MB-14-W	8			16x1.5	14x1.5		
	S	630	HD-GE-10S-MB-16-W	10	18x1.5	16x1.5		
			HD-GE-12S-MB-18-W	12	20x1.5	18x1.5		
			HD-GE-16S-MB-22-W	16	24x1.5	22x1.5		
			HD-GE-20S-MB-27-W	20	30x2	27x2		
		400	HD-GE-25S-MB-33-W	25	36x2	33x2		
			HD-GE-30S-MB-42-W	30	42x2	42x2		
			250	HD-GE-38S-MB-48-W	38	52x2	48x2	

GE - MB

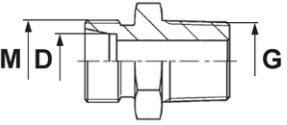
description	series	press. [bar]	code (galvanized steel)	D [mm]	M [mm]	G [mm]
Straight connector with metric tapered thread 	LL	100	HD-GE-04LL-MT-08-W	4	8x1	8x1
			HD-GE-06LL-MT-10-W	6	10x1	10x1
			HD-GE-08LL-MT-10-W	8	12x1	10x1
	L	250	HD-GE-06L-MT-12-W	6	12x1.5	12x1.5
			HD-GE-08L-MT-12-W	8	14x1.5	12x1.5
			HD-GE-08L-MT-14-W	8	14x1.5	14x1.5
			HD-GE-10L-MT-14-W	10	16x1.5	14x1.5
			HD-GE-10L-MT-16-W	10	16x1.5	16x1.5
			HD-GE-12L-MT-16-W	12	18x1.5	16x1.5
			HD-GE-12L-MT-18-W	12	18x1.5	18x1.5

GE - MT

HIGH PRESSURE - DIN 2353 connectors

DIN 2353 Eaton Walterscheid™

description	series	press. [bar]	code (galvanized steel)	D [mm]	M [mm]	G [NPT]	
Straight connector with NPT tapered thread 	LL	100	HD-GE-04LL-NT-02-W	4	8x1	1/8	
			HD-GE-06LL-NT-02-W	6	10x1	1/8	
			HD-GE-08LL-NT-02-W	8	12x1	1/8	
	L	315	HD-GE-06L-NT-02-W	6	12x1.5	1/8	
			HD-GE-06L-NT-04-W	6	12x1.5	1/4	
			HD-GE-08L-NT-04-W	8	14x1.5	1/4	
			HD-GE-10L-NT-04-W	10	16x1.5	1/4	
			HD-GE-10L-NT-06-W	10	16x1.5	3/8	
			HD-GE-12L-NT-04-W	12	18x1.5	1/4	
			HD-GE-12L-NT-06-W	12	18x1.5	3/8	
			HD-GE-12L-NT-08-W	12	18x1.5	1/2	
			HD-GE-15L-NT-08-W	15	22x1.5	1/2	
			HD-GE-18L-NT-08-W	18	26x1.5	1/2	
			160	HD-GE-22L-NT-12-W	22	30x2	3/4
				HD-GE-28L-NT-16-W	28	36x2	1
				HD-GE-35L-NT-20-W	35	45x2	1.1/4
				HD-GE-42L-NT-24-W	42	52x2	1.1/2
				S	630	HD-GE-06S-NT-04-W	6
	HD-GE-08S-NT-04-W	8				16x1.5	1/4
	HD-GE-10S-NT-04-W	10	18x1.5			1/4	
	HD-GE-10S-NT-06-W	10	18x1.5			3/8	
	HD-GE-12S-NT-04-W	12	20x1.5			1/4	
	HD-GE-12S-NT-06-W	12	20x1.5			3/8	
	HD-GE-12S-NT-08-W	12	20x1.5		1/2		
	400	HD-GE-16S-NT-08-W	16		24x1.5	1/2	
		HD-GE-20S-NT-12-W	20		30x2	3/4	
		HD-GE-25S-NT-16-W	25	36x2	1		
	315	HD-GE-30S-NT-20-W	30	42x2	1.1/4		
		HD-GE-38S-NT-24-W	38	52x2	1.1/2		

GE - NT

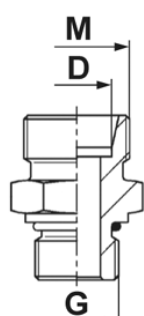
description	series	press. [bar]	code (galvanized steel)	D [mm]	M [mm]	G [UN-UNF]	
Straight connector with UN-UNF thread, O-ring seal 	L	400	HD-GE-06L-UN-09-W	6	12x1.5	9/16-18	
			HD-GE-08L-UN-07-W	8	14x1.5	7/16-20	
			HD-GE-08L-UN-09-W	8	14x1.5	9/16-18	
			HD-GE-10L-UN-07-W	10	16x1.5	7/16-20	
			HD-GE-10L-UN-09-W	10	16x1.5	9/16-18	
			HD-GE-10L-UN-12-W	10	16x1.5	3/4-16	
			HD-GE-12L-UN-09-W	12	18x1.5	9/16-18	
			HD-GE-12L-UN-12-W	12	18x1.5	3/4-16	
			HD-GE-12L-UN-14-W	12	18x1.5	7/8-14	
			HD-GE-15L-UN-12-W	15	22x1.5	3/4-16	
			HD-GE-15L-UN-14-W	15	22x1.5	7/8-14	
			HD-GE-18L-UN-12-W	18	26x1.5	3/4-16	
			HD-GE-18L-UN-14-W	18	26x1.5	7/8-14	
			250	HD-GE-22L-UN-14-W	22	30x2	7/8-14
				HD-GE-22L-UN-17-W	22	30x2	1.1/16-12
				HD-GE-28L-UN-14-W	28	36x2	7/8-14
				HD-GE-28L-UN-21-W	28	36x2	1.5/16-12
				HD-GE-35L-UN-26-W	35	45x2	1.5/8-12
	HD-GE-42L-UN-26-W	42		52x2	1.5/8-12		
	S	630		HD-GE-12S-UN-12-W	12	20x1.5	3/4-16
				HD-GE-16S-UN-12-W	16	24x1.5	3/4-16
				HD-GE-16S-UN-14-W	16	24x1.5	7/8-14
		400		HD-GE-20S-UN-12-W	20	30x2	3/4-16
			HD-GE-20S-UN-14-W	20	30x2	7/8-14	
			HD-GE-20S-UN-17-W	20	30x2	1.1/16-12	
	315	HD-GE-25S-UN-21-W	25	36x2	1.5/16-12		
		HD-GE-30S-UN-26-W	30	42x2	1.5/8-12		

GE - UN

HIGH PRESSURE - DIN 2353 connectors

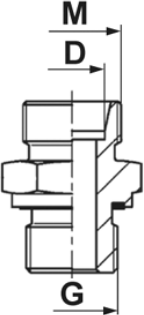
description	series	press. [bar]	code (galvanized steel)	D [mm]	M [mm]	G [BSP]
Straight connector with BSP thread, DIN 3852-B seal 	L	500	HD-GE-06L-BE-02-W	6	12x1.5	1/8
			HD-GE-06L-BE-04-W	6	12x1.5	1/4
			HD-GE-08L-BE-02-W	8	14x1.5	1/8
			HD-GE-08L-BE-04-W	8	14x1.5	1/4
		HD-GE-08L-BE-06-W	8	14x1.5	3/8	
		500	HD-GE-10L-BE-04-W	10	16x1.5	1/4
			HD-GE-10L-BE-06-W	10	16x1.5	3/8
			HD-GE-10L-BE-08-W	10	16x1.5	1/2
			HD-GE-12L-BE-04-W	12	18x1.5	1/4
		400	HD-GE-12L-BE-06-W	12	18x1.5	3/8
			HD-GE-12L-BE-08-W	12	18x1.5	1/2
			HD-GE-15L-BE-06-W	15	22x1.5	3/8
			HD-GE-15L-BE-08-W	15	22x1.5	1/2
			HD-GE-18L-BE-08-W	18	26x1.5	1/2
			HD-GE-18L-BE-12-W	18	26x1.5	3/4
			HD-GE-22L-BE-12-W	22	30x2	3/4
			HD-GE-28L-BE-16-W	28	36x2	1
		250	HD-GE-35L-BE-20-W	35	45x2	1.1/4
			HD-GE-42L-BE-24-W	42	52x2	1.1/2
			800	HD-GE-06S-BE-04-W	6	14x1.5
	HD-GE-08S-BE-04-W			8	16x1.5	1/4
	HD-GE-08S-BE-06-W			8	16x1.5	3/8
	HD-GE-10S-BE-04-W			10	18x1.5	1/4
	HD-GE-10S-BE-06-W			10	18x1.5	3/8
	HD-GE-10S-BE-08-W			10	18x1.5	1/2
	630	HD-GE-12S-BE-04-W		12	20x1.5	1/4
		HD-GE-12S-BE-06-W		12	20x1.5	3/8
		HD-GE-12S-BE-08-W	12	20x1.5	1/2	
		HD-GE-14S-BE-08-W	14	22x1.5	1/2	
		HD-GE-16S-BE-06-W	16	24x1.5	3/8	
		HD-GE-16S-BE-08-W	16	24x1.5	1/2	
	420	HD-GE-16S-BE-12-W	16	24x1.5	3/4	
		HD-GE-20S-BE-12-W	20	30x2	3/4	
		HD-GE-25S-BE-12-W	25	36x2	3/4	
		HD-GE-25S-BE-16-W	25	36x2	1	
		HD-GE-30S-BE-20-W	30	42x2	1.1/4	
		HD-GE-38S-BE-24-W	38	52x2	1.1/2	

GE - BE

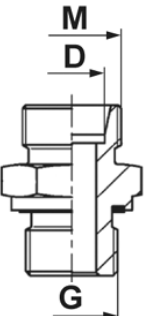
description	series	press. [bar]	code (galvanized steel)	D [mm]	M [mm]	G [mm]
Straight connector with metric thread, DIN 3852-E seal 	L	500	HD-GE-06L-ME-10-W	6	12x1.5	10x1
			HD-GE-08L-ME-12-W	8	14x1.5	12x1.5
			HD-GE-10L-ME-14-W	10	16x1.5	14x1.5
			HD-GE-10L-ME-18-W	10	16x1.5	18x1.5
			HD-GE-10L-ME-22-W	10	16x1.5	22x1.5
		400	HD-GE-12L-ME-16-W	12	18x1.5	16x1.5
			HD-GE-12L-ME-18-W	12	18x1.5	18x1.5
			HD-GE-12L-ME-22-W	12	18x1.5	22x1.5
			HD-GE-15L-ME-18-W	15	22x1.5	18x1.5
			HD-GE-15L-ME-22-W	15	22x1.5	22x1.5
			HD-GE-18L-ME-18-W	18	26x1.5	18x1.5
			HD-GE-18L-ME-22-W	18	26x1.5	22x1.5
			HD-GE-22L-ME-26-W	22	30x2	26x1.5
			HD-GE-28L-ME-33-W	28	36x2	33x2
			HD-GE-35L-ME-42-W	35	45x2	42x2
	HD-GE-42L-ME-48-W	42	52x2	48x2		
	S	800	HD-GE-06S-ME-12-W	6	14x1.5	12x1.5
			HD-GE-08S-ME-14-W	8	16x1.5	14x1.5
			HD-GE-10S-ME-16-W	10	18x1.5	16x1.5
		630	HD-GE-12S-ME-18-W	12	20x1.5	18x1.5
			HD-GE-16S-ME-22-W	16	24x1.5	22x1.5
			HD-GE-20S-ME-27-W	20	30x2	27x2
		420	HD-GE-25S-ME-33-W	25	36x2	33x2
			HD-GE-30S-ME-42-W	30	42x2	42x2
			HD-GE-38S-ME-48-W	38	52x2	48x2

GE - ME

HIGH PRESSURE - DIN 2353 connectors

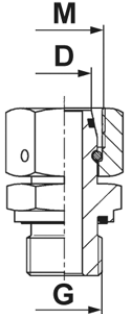
description	series	press. [bar]	code (galvanized steel)	D [mm]	M [mm]	G [BSP]	
Adjustable straight connector with BSP thread, DIN 3852-E seal 	L	500	HD-EVGEO-06L-BE-02-W	6	12x1.5	1/8	
			HD-EVGEO-08L-BE-04-W	8	14x1.5	1/4	
			HD-EVGEO-10L-BE-04-W	10	16x1.5	1/4	
		400	HD-EVGEO-12L-BE-04-W	12	18x1.5	1/4	
			HD-EVGEO-12L-BE-06-W	12	18x1.5	3/8	
			HD-EVGEO-15L-BE-08-W	15	22x1.5	1/2	
			HD-EVGEO-18L-BE-08-W	18	26x1.5	1/2	
			250	HD-EVGEO-22L-BE-12-W	22	30x2	3/4
				HD-EVGEO-28L-BE-16-W	28	36x2	1
		HD-EVGEO-35L-BE-20-W		35	45x2	1.1/4	
		S	800	HD-EVGEO-42L-BE-24-W	42	52x2	1.1/2
				HD-EVGEO-06S-BE-04-W	6	14x1.5	1/4
	HD-EVGEO-08S-BE-04-W			8	16x1.5	1/4	
	630		HD-EVGEO-10S-BE-06-W	10	18x1.5	3/8	
			HD-EVGEO-12S-BE-06-W	12	20x1.5	3/8	
			HD-EVGEO-12S-BE-08-W	12	20x1.5	1/2	
	420		HD-EVGEO-16S-BE-08-W	16	24x1.5	1/2	
			HD-EVGEO-20S-BE-12-W	20	30x2	3/4	
			HD-EVGEO-25S-BE-16-W	25	36x2	1	
			400	HD-EVGEO-30S-BE-20-W	30	42x2	1.1/4
				HD-EVGEO-38S-BE-24-W	38	52x2	1.1/2

EVGEO - BE

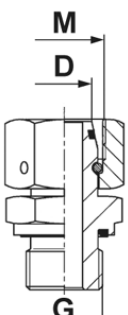
description	series	press. [bar]	code (galvanized steel)	D [mm]	M [mm]	G [mm]	
Adjustable straight connector with metric thread, DIN 3852-E seal 	L	500	HD-EVGEO-06L-ME-10-W	6	12x1.5	10x1	
			HD-EVGEO-08L-ME-12-W	8	14x1.5	12x1.5	
			HD-EVGEO-10L-ME-14-W	10	16x1.5	14x1.5	
		400	HD-EVGEO-12L-ME-16-W	12	18x1.5	16x1.5	
			HD-EVGEO-15L-ME-18-W	15	22x1.5	18x1.5	
			HD-EVGEO-18L-ME-22-W	18	26x1.5	22x1.5	
			250	HD-EVGEO-22L-ME-26-W	22	30x2	26x1.5
				HD-EVGEO-28L-ME-33-W	28	36x2	33x2
				HD-EVGEO-35L-ME-42-W	35	45x2	42x2
		S	800	HD-EVGEO-42L-ME-48-W	42	52x2	48x2
				HD-EVGEO-06S-ME-12-W	6	14x1.5	12x1.5
				HD-EVGEO-08S-ME-14-W	8	16x1.5	14x1.5
	630		HD-EVGEO-10S-ME-16-W	10	18x1.5	16x1.5	
			HD-EVGEO-12S-ME-18-W	12	20x1.5	18x1.5	
			HD-EVGEO-16S-ME-22-W	16	24x1.5	22x1.5	
	420		HD-EVGEO-20S-ME-27-W	20	30x2	27x2	
			HD-EVGEO-25S-ME-33-W	25	36x2	33x2	
			400	HD-EVGEO-30S-ME-42-W	30	42x2	42x2
				HD-EVGEO-38S-ME-48-W	38	52x2	48x2

EVGEO - ME

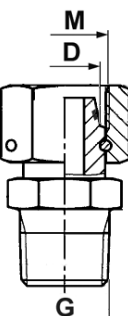
description	series	press. [bar]	code (galvanized steel)	D [mm]	M [mm]	G [NPT]		
Adjustable straight connector with NPT tapered thread 	L	250	HD-EVGEO-06L-NT-02-W	6	12x1.5	1/8		
			HD-EVGEO-08L-NT-04-W	8	14x1.5	1/4		
			HD-EVGEO-10L-NT-04-W	10	16x1.5	1/4		
			HD-EVGEO-12L-NT-06-W	12	18x1.5	3/8		
			HD-EVGEO-15L-NT-08-W	15	22x1.5	1/2		
			160	HD-EVGEO-18L-NT-08-W	18	26x1.5	1/2	
		HD-EVGEO-22L-NT-12-W		22	30x2	3/4		
		HD-EVGEO-28L-NT-16-W		28	36x2	1		
		100	HD-EVGEO-35L-NT-20-W	35	45x2	1.1/4		
			HD-EVGEO-42L-NT-24-W	42	52x2	1.1/2		
			S	630	HD-EVGEO-06S-NT-04-W	6	14x1.5	1/4
					HD-EVGEO-08S-NT-04-W	8	16x1.5	1/4
	HD-EVGEO-10S-NT-06-W				10	18x1.5	3/8	
	400			HD-EVGEO-12S-NT-06-W	12	20x1.5	3/8	
		HD-EVGEO-16S-NT-08-W		16	24x1.5	1/2		
		HD-EVGEO-20S-NT-12-W		20	30x2	3/4		
	250	HD-EVGEO-25S-NT-16-W	25	36x2	1			
		HD-EVGEO-30S-NT-20-W	30	42x2	1.1/4			
		HD-EVGEO-38S-NT-24-W	38	52x2	1.1/2			

EVGEO - NT

HIGH PRESSURE - DIN 2353 connectors

DIN 2353 Eaton Walterscheid™

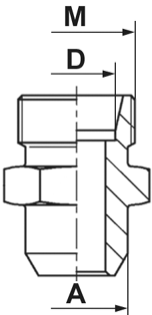
description	series	press. [bar]	code (black steel)	D [mm]	M [mm]	A [mm]
Straight connector with weld-in ends 	L	500	HD-AS-06L-W	6	12x1.5	10
			HD-AS-08L-W	8	14x1.5	12
			HD-AS-10L-W	10	16x1.5	14
		400	HD-AS-12L-W	12	18x1.5	16
			HD-AS-15L-W	15	22x1.5	19
			HD-AS-18L-W	18	26x1.5	22
		250	HD-AS-22L-W	22	30x2	27
			HD-AS-28L-W	28	36x2	32
			HD-AS-35L-W	35	45x2	40
	S	800	HD-AS-42L-W	42	52x2	46
			HD-AS-06S-W	6	14x1.5	11
			HD-AS-08S-W	8	16x1.5	13
		630	HD-AS-10S-W	10	18x1.5	15
			HD-AS-12S-W	12	20x1.5	17
			HD-AS-16S-W	16	24x1.5	21
		420	HD-AS-20S-W	20	30x2	26
			HD-AS-25S-W	25	36x2	31
			HD-AS-30S-W	30	42x2	36
HD-AS-38S-W	38	52x2	44			

AS

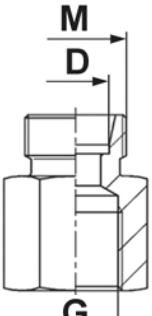
description	series	press. [bar]	code (galvanized steel)	D [mm]	M [mm]	G [BSP]
Straight connector with BSP female thread 	L	250	HD-GAI-06L-B-02-W	6	12x1.5	1/8
			HD-GAI-08L-B-04-W	8	14x1.5	1/4
			HD-GAI-10L-B-04-W	10	16x1.5	1/4
			HD-GAI-12L-B-04-W	12	18x1.5	1/4
			HD-GAI-12L-B-06-W	12	18x1.5	3/8
		HD-GAI-15L-B-08-W	15	22x1.5	1/2	
		160	HD-GAI-18L-B-08-W	18	26x1.5	1/2
			HD-GAI-22L-B-12-W	22	30x2	3/4
			100	HD-GAI-28L-B-16-W	28	36x2
	HD-GAI-35L-B-20-W			35	45x2	1.1/4
	S	630	HD-GAI-42L-B-24-W	42	52x2	1.1/2
			HD-GAI-06S-B-04-W	6	14x1.5	1/4
			HD-GAI-08S-B-04-W	8	16x1.5	1/4
			HD-GAI-10S-B-06-W	10	18x1.5	3/8
			HD-GAI-12S-B-06-W	12	20x1.5	3/8
			HD-GAI-16S-B-08-W	16	24x1.5	1/2
		400	HD-GAI-20S-B-12-W	20	30x2	3/4
			HD-GAI-25S-B-16-W	25	36x2	1
			HD-GAI-30S-B-20-W	30	42x2	1.1/4
		250	HD-GAI-38S-B-24-W	38	52x2	1.1/2

GAI - B

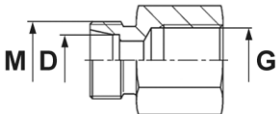
description	series	press. [bar]	code (galvanized steel)	D [mm]	M [mm]	G [mm]
Straight connector with metric female thread 	L	250	HD-GAI-06L-M-10-W	6	12x1.5	10x1
			HD-GAI-08L-M-12-W	8	14x1.5	12x1.5
			HD-GAI-10L-M-14-W	10	16x1.5	14x1.5
			HD-GAI-12L-M-16-W	12	18x1.5	16x1.5
			HD-GAI-15L-M-18-W	15	22x1.5	18x1.5
	160	HD-GAI-18L-M-22-W	18	26x1.5	22x1.5	
		HD-GAI-22L-M-26-W	22	30x2	26x1.5	
		630	HD-GAI-06S-M-12-W	6	14x1.5	12x1.5
			HD-GAI-08S-M-14-W	8	16x1.5	14x1.5
	HD-GAI-10S-M-16-W		10	18x1.5	16x1.5	
	400	HD-GAI-12S-M-18-W	12	20x1.5	18x1.5	
		HD-GAI-16S-M-22-W	16	24x1.5	22x1.5	
		HD-GAI-20S-M-27-W	20	30x2	27x2	

GAI - M

HIGH PRESSURE - DIN 2353 connectors

DIN 2353 Eaton Walterscheid™

description	series	press. [bar]	code (galvanized steel)	G1 [BSP]	G2 [BSP]
Straight BSP (DIN 3852-E seal) connector with BSP female thread		400	HD-RI-02-04-BE-W	1/8	1/4
			HD-RI-02-06-BE-W	1/8	3/8
			HD-RI-04-02-BE-W	1/4	1/8
			HD-RI-04-06-BE-W	1/4	3/8
			HD-RI-04-08-BE-W	1/4	1/2
			HD-RI-04-12-BE-W	1/4	3/4
		630	HD-RI-06-02-BE-W	3/8	1/8
		400	HD-RI-06-04-BE-W	3/8	1/4
			HD-RI-06-08-BE-W	3/8	1/2
			HD-RI-06-12-BE-W	3/8	3/4
		630	HD-RI-08-02-BE-W	1/2	1/8
			HD-RI-08-04-BE-W	1/2	1/4
		400	HD-RI-08-06-BE-W	1/2	3/8
			HD-RI-08-12-BE-W	1/2	3/4
			HD-RI-08-16-BE-W	1/2	1
			HD-RI-12-04-BE-W	3/4	1/4
			HD-RI-12-06-BE-W	3/4	3/8
			HD-RI-12-08-BE-W	3/4	1/2
		250	HD-RI-12-16-BE-W	3/4	1
			HD-RI-12-20-BE-W	3/4	1.1/4
		400	HD-RI-12-24-BE-W	3/4	1.1/2
			HD-RI-16-04-BE-W	1	1/4
			HD-RI-16-06-BE-W	1	3/8
			HD-RI-16-08-BE-W	1	1/2
		250	HD-RI-16-12-BE-W	1	3/4
			HD-RI-16-20-BE-W	1	1.1/4
		400	HD-RI-16-24-BE-W	1	1.1/2
			HD-RI-20-08-BE-W	1.1/4	1/2
			HD-RI-20-12-BE-W	1.1/4	3/4
		250	HD-RI-20-16-BE-W	1.1/4	1
			HD-RI-20-24-BE-W	1.1/4	1.1/2
		400	HD-RI-24-08-BE-W	1.1/2	1/2
			HD-RI-24-12-BE-W	1.1/2	3/4
			HD-RI-24-16-BE-W	1.1/2	1
		250	HD-RI-24-20-BE-W	1.1/2	1.1/4

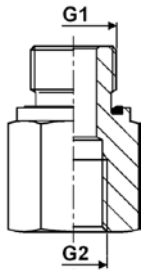

RI - BE

HIGH PRESSURE - DIN 2353 connectors

DIN 2353 Eaton Walterscheid™

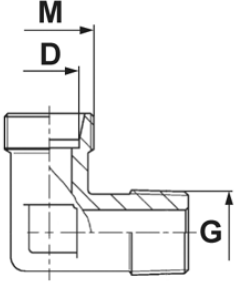
description	series	press. [bar]	code (galvanized steel)	D [mm]	M [mm]	G [BSPT]
90° connector with BSPT tapered thread  WE - BT	LL	100	HD-WE-04LL-BT-02-W	4	8x1	1/8
			HD-WE-06LL-BT-02-W	6	10x1	1/8
			HD-WE-08LL-BT-02-W	8	12x1	1/8
	L	250	HD-WE-06L-BT-02-W	6	12x1.5	1/8
			HD-WE-06L-BT-04-W	6	12x1.5	1/4
			HD-WE-08L-BT-04-W	8	14x1.5	1/4
			HD-WE-10L-BT-04-W	10	16x1.5	1/4
			HD-WE-10L-BT-06-W	10	16x1.5	3/8
			HD-WE-12L-BT-04-W	12	18x1.5	1/4
			HD-WE-12L-BT-06-W	12	18x1.5	3/8
			HD-WE-15L-BT-08-W	15	22x1.5	1/2
	S	630	HD-WE-18L-BT-08-W	18	26x1.5	1/2
			HD-WE-06S-BT-04-W	6	14x1.5	1/4
			HD-WE-08S-BT-04-W	8	16x1.5	1/4
	S	400	HD-WE-10S-BT-06-W	10	18x1.5	3/8
			HD-WE-12S-BT-06-W	12	20x1.5	3/8
			HD-WE-16S-BT-08-W	16	24x1.5	1/2

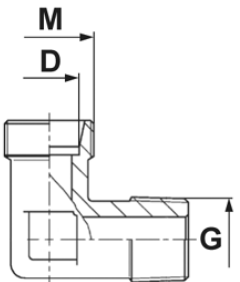
description	series	press. [bar]	code (galvanized steel)	D [mm]	M [mm]	G [mm]
90° connector with metric tapered thread  WE - MT	LL	100	HD-WE-04LL-MT-08-W	4	8x1	8x1
			HD-WE-06LL-MT-10-W	6	10x1	10x1
			HD-WE-08LL-MT-10-W	8	12x1	10x1
	L	250	HD-WE-06L-MT-10-W	6	12x1.5	10x1
			HD-WE-08L-MT-12-W	8	14x1.5	12x1.5
			HD-WE-10L-MT-14-W	10	16x1.5	14x1.5
			HD-WE-12L-MT-16-W	12	18x1.5	16x1.5
			HD-WE-15L-MT-18-W	15	22x1.5	18x1.5
	S	630	HD-WE-18L-MT-22-W	18	26x1.5	22x1.5
			HD-WE-06S-MT-12-W	6	14x1.5	12x1.5
			HD-WE-08S-MT-14-W	8	16x1.5	14x1.5
	S	400	HD-WE-10S-MT-16-W	10	18x1.5	16x1.5
			HD-WE-12S-MT-18-W	12	20x1.5	18x1.5
			HD-WE-16S-MT-22-W	16	24x1.5	22x1.5

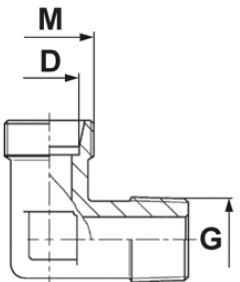
description	series	press. [bar]	code (galvanized steel)	D [mm]	M [mm]	G [NPT]	
90° connector with NPT tapered thread  WE - NT	LL	100	HD-WE-04LL-NT-02-W	4	8x1	1/8	
			HD-WE-06LL-NT-02-W	6	10x1	1/8	
			HD-WE-08LL-NT-02-W	8	12x1	1/8	
	L	250	HD-WE-06L-NT-02-W	6	12x1.5	1/8	
			HD-WE-08L-NT-04-W	8	14x1.5	1/4	
			HD-WE-10L-NT-04-W	10	16x1.5	1/4	
			HD-WE-12L-NT-04-W	12	18x1.5	1/4	
			HD-WE-12L-NT-06-W	12	18x1.5	3/8	
			HD-WE-15L-NT-08-W	15	22x1.5	1/2	
			HD-WE-18L-NT-08-W	18	26x1.5	1/2	
			HD-WE-22L-NT-12-W	22	30x2	3/4	
	S	100	HD-WE-28L-NT-16-W	28	36x2	1	
			630	HD-WE-06S-NT-04-W	6	14x1.5	1/4
				HD-WE-08S-NT-04-W	8	16x1.5	1/4
	HD-WE-10S-NT-06-W	10		18x1.5	3/8		
	S	400	HD-WE-12S-NT-06-W	12	20x1.5	3/8	
			HD-WE-16S-NT-08-W	16	24x1.5	1/2	
			HD-WE-20S-NT-12-W	20	30x2	3/4	
			HD-WE-25S-NT-16-W	25	36x2	1	

HIGH PRESSURE - DIN 2353 connectors

DIN 2353 Eaton Walterscheid™

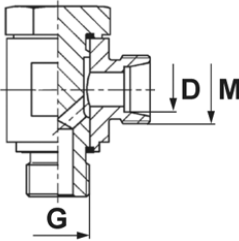
description	series	press. [bar]	code (galvanized steel)	D [mm]	M [mm]	G [BSP]			
BANJO connector with BSP thread, DIN 3852-E seal 	LL	100	HD-WH-04LL-BE-02-W	4	8x1	1/8			
			HD-WH-06LL-BE-02-W	6	10x1	1/8			
			HD-WH-08LL-BE-02-W	8	12x1	1/8			
	L	500	500	HD-WH-06L-BE-02-W	6	12x1.5	1/8		
				HD-WH-06L-BE-04-W	6	12x1.5	1/4		
				HD-WH-08L-BE-04-W	8	14x1.5	1/4		
				HD-WH-10L-BE-04-W	10	16x1.5	1/4		
				HD-WH-12L-BE-04-W	12	18x1.5	1/4		
		400	400	HD-WH-12L-BE-06-W	12	18x1.5	3/8		
				HD-WH-15L-BE-08-W	15	22x1.5	1/2		
				HD-WH-18L-BE-08-W	18	26x1.5	1/2		
				HD-WH-22L-BE-12-W	22	30x2	3/4		
				HD-WH-28L-BE-16-W	28	36x2	1		
		250	250	HD-WH-35L-BE-20-W	35	45x2	1.1/4		
				HD-WH-42L-BE-24-W	42	52x2	1.1/2		
				S	500	HD-WH-06S-BE-04-W	6	14x1.5	1/4
						HD-WH-08S-BE-04-W	8	16x1.5	1/4
						HD-WH-10S-BE-06-W	10	18x1.5	3/8
	400	400	HD-WH-12S-BE-06-W	12	20x1.5	3/8			
			HD-WH-14S-BE-08-W	14	22x1.5	1/2			
			HD-WH-16S-BE-08-W	16	24x1.5	1/2			
	315	315	HD-WH-20S-BE-12-W	20	30x2	3/4			
	250	250	HD-WH-25S-BE-16-W	25	36x2	1			
			HD-WH-30S-BE-20-W	30	42x2	1.1/4			
	HD-WH-38S-BE-24-W	38	52x2	1.1/2					

WH - BE

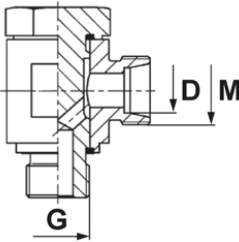
description	series	press. [bar]	code (galvanized steel)	D [mm]	M [mm]	G [mm]			
BANJO connector with metric thread, DIN 3852-E seal 	LL	100	HD-WH-04LL-ME-08-W	4	8x1	8x1			
			HD-WH-06LL-ME-10-W	6	10x1	10x1			
			HD-WH-08LL-ME-10-W	8	12x1	10x1			
	L	500	500	HD-WH-06L-ME-10-W	6	12x1.5	10x1		
				HD-WH-08L-ME-12-W	8	14x1.5	12x1.5		
				HD-WH-10L-ME-14-W	10	16x1.5	14x1.5		
				HD-WH-12L-ME-16-W	12	18x1.5	16x1.5		
				HD-WH-12L-ME-18-W	12	18x1.5	18x1.5		
		400	400	HD-WH-15L-ME-18-W	15	22x1.5	18x1.5		
				HD-WH-18L-ME-22-W	18	26x1.5	22x1.5		
				250	250	HD-WH-22L-ME-26-W	22	30x2	26x1.5
						HD-WH-28L-ME-33-W	28	36x2	33x2
						HD-WH-35L-ME-42-W	35	45x2	42x2
		HD-WH-42L-ME-48-W	42			52x2	48x2		
		S	500	500	HD-WH-06S-ME-12-W	6	14x1.5	12x1.5	
					HD-WH-08S-ME-14-W	8	16x1.5	14x1.5	
					HD-WH-10S-ME-16-W	10	18x1.5	16x1.5	
			400	400	HD-WH-12S-ME-18-W	12	20x1.5	18x1.5	
	HD-WH-16S-ME-22-W				16	24x1.5	22x1.5		
	HD-WH-20S-ME-27-W				20	30x2	27x2		
	250		250	HD-WH-25S-ME-33-W	25	36x2	33x2		
				HD-WH-30S-ME-42-W	30	42x2	42x2		
				HD-WH-38S-ME-48-W	38	52x2	48x2		

WH - ME

HIGH PRESSURE - DIN 2353 connectors

DIN 2353 Eaton Walterscheid™

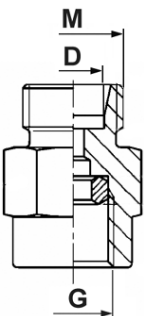
description	series	press. [bar]	code (galvanized steel)	D [mm]	M [mm]	G [BSP]
Pressure gauge connector with BSP thread  MAV - B	L	500	HD-MAV-06L-B-04-W	6	12x1.5	1/4
			HD-MAV-08L-B-04-W	8	14x1.5	1/4
			HD-MAV-10L-B-04-W	10	16x1.5	1/4
	S	630	HD-MAV-12L-B-04-W	12	18x1.5	1/4
			HD-MAV-06S-B-08-W	6	14x1.5	1/2
			HD-MAV-08S-B-08-W	8	16x1.5	1/2
			HD-MAV-10S-B-08-W	10	18x1.5	1/2
			HD-MAV-12S-B-08-W	12	20x1.5	1/2

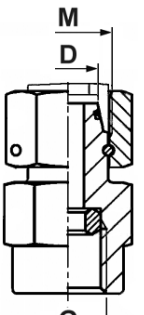
description	series	press. [bar]	code (galvanized steel)	D [mm]	M [mm]	G [BSP]
Pressure gauge connector with BSP thread  FAV - B	L	500	HD-FAV-06L-B-04-W	6	12x1.5	1/4
			HD-FAV-08L-B-04-W	8	14x1.5	1/4
			HD-FAV-10L-B-04-W	10	16x1.5	1/4
	S	630	HD-FAV-12L-B-04-W	12	18x1.5	1/4
			HD-FAV-06S-B-08-W	6	14x1.5	1/2
			HD-FAV-08S-B-08-W	8	16x1.5	1/2
			HD-FAV-10S-B-08-W	10	18x1.5	1/2
			HD-FAV-12S-B-08-W	12	20x1.5	1/2

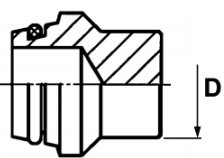
description	series	press. [bar]	code (galvanized steel)	D [mm]		
Dust plug  VKA	LL	100	HD-VKA-04LL-W	4		
			HD-VKA-06LL-W	6		
			HD-VKA-08LL-W	8		
	L/S	800	HD-VKA-06L-S-W	6		
			HD-VKA-08L-S-W	8		
			HD-VKA-10L-S-W	10		
			HD-VKA-12L-S-W	12		
			L	400	HD-VKA-15L-W	15
					HD-VKA-18L-W	18
	HD-VKA-22L-W	22				
	HD-VKA-28L-W	29				
	S	420	HD-VKA-35L-W	35		
			HD-VKA-42L-W	42		
			HD-VKA-16S-W	16		
			HD-VKA-20S-W	20		
			HD-VKA-25S-W	25		
			HD-VKA-30S-W	30		
HD-VKA-38S-W			38			

HIGH PRESSURE - DIN 2353 connectors

DIN 2353 Eaton Walterscheid™

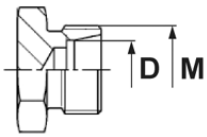
description	series	press. [bar]	code (galvanized steel)	D [mm]	M [mm]
 <p>ROV</p>	L	500	HD-ROV-06L-W	6	12x1.5
			HD-ROV-08L-W	8	14x1.5
			HD-ROV-10L-W	10	16x1.5
		HD-ROV-12L-W	12	18x1.5	
		HD-ROV-15L-W	15	22x1.5	
		HD-ROV-18L-W	18	26x1.5	
		250	HD-ROV-22L-W	22	30x2
			HD-ROV-28L-W	28	36x2
			HD-ROV-35L-W	35	45x2
	S	800	HD-ROV-06S-W	6	14x1.5
			HD-ROV-08S-W	8	16x1.5
			HD-ROV-10S-W	10	18x1.5
		630	HD-ROV-12S-W	12	20x1.5
			HD-ROV-16S-W	16	24x1.5
			HD-ROV-20S-W	20	30x2
		420	HD-ROV-25S-W	25	36x2
			HD-ROV-30S-W	30	42x2
			HD-ROV-38S-W	38	52x2

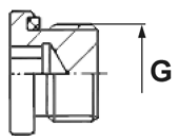
description	series	press. [bar]	code (galvanized steel)	G [BSP]
 <p>VSTI - BE</p>	-	400	HD-VSTI-02-BE-W	1/8
			HD-VSTI-04-BE-W	1/4
			HD-VSTI-06-BE-W	3/8
			HD-VSTI-08-BE-W	1/2
			HD-VSTI-12-BE-W	3/4
			HD-VSTI-16-BE-W	1
	250	HD-VSTI-20-BE-W	1.1/4	
		HD-VSTI-24-BE-W	1.1/2	
	400	HD-VSTI-H-20-BE-W	1.1/4	
		HD-VSTI-H-24-BE-W	1.1/2	

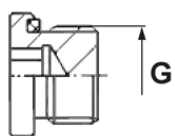
description	series	press. [bar]	code (galvanized steel)	G [mm]
 <p>VSTI - ME</p>	-	400	HD-VSTI-10-ME-W	10X1
			HD-VSTI-12-ME-W	12X1.5
			HD-VSTI-14-ME-W	14X1.5
			HD-VSTI-16-ME-W	16X1.5
			HD-VSTI-18-ME-W	18X1.5
			HD-VSTI-20-ME-W	20X1.5
			HD-VSTI-22-ME-W	22X1.5
			HD-VSTI-26-ME-W	26X1.5
			HD-VSTI-27-ME-W	27X2
			HD-VSTI-33-ME-W	33X2
	250	HD-VSTI-42-ME-W	42X2	
		HD-VSTI-48-ME-W	48X2	
	400	HD-VSTI-H-42-ME-W	42X2	
		HD-VSTI-H-48-ME-W	48X2	

HIGH PRESSURE - DIN 2353 connectors

DIN 2353 Eaton Walterscheid™

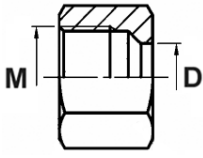
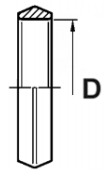
description	series	press. [bar]	code (galvanized steel)	D [mm]	M [mm]	
WALForm nut with seal   MWF	L	500	HD-MWF-06L-W	6	12x1.5	
			HD-MWF-08L-W	8	14x1.5	
			HD-MWF-10L-W	10	16x1.5	
		400	HD-MWF-12L-W	12	18x1.5	
			HD-MWF-15L-W	15	22x1.5	
			HD-MWF-18L-W	18	26x1.5	
			250	HD-MWF-22L-W	22	30x2
				HD-MWF-28L-W	28	36x2
				HD-MWF-35L-W	35	45x2
	S	800	HD-MWF-42L-W	42	52x2	
			HD-MWF-06S-W	6	14x1.5	
			HD-MWF-08S-W	8	16x1.5	
		630	HD-MWF-10S-W	10	18x1.5	
			HD-MWF-12S-W	12	20x1.5	
			HD-MWF-16S-W	16	24x1.5	
		420	HD-MWF-20S-W	20	30x2	
			HD-MWF-25S-W	25	36x2	
			HD-MWF-30S-W	30	42x2	
			HD-MWF-38S-W	38	52x2	

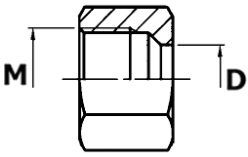
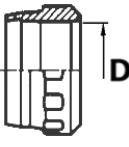
description	series	press. [bar]	code (galvanized steel)	D [mm]	M [mm]	
WALPro nut with cutting ring   MWP	LL	100	HD-MWP-04LL-W	4	8x1	
			HD-MWP-06LL-W	6	10x1	
			HD-MWP-08LL-W	8	12x1	
	L	500	HD-MWP-06L-W	6	12x1.5	
			HD-MWP-08L-W	8	14x1.5	
			HD-MWP-10L-W	10	16x1.5	
		400	HD-MWP-12L-W	12	18x1.5	
			HD-MWP-15L-W	15	22x1.5	
			HD-MWP-18L-W	18	26x1.5	
			250	HD-MWP-22L-W	22	30x2
				HD-MWP-28L-W	28	36x2
				HD-MWP-35L-W	35	45x2
	S	800	HD-MWP-42L-W	42	52x2	
			HD-MWP-06S-W	6	14x1.5	
			HD-MWP-08S-W	8	16x1.5	
		630	HD-MWP-10S-W	10	18x1.5	
			HD-MWP-12S-W	12	20x1.5	
			HD-MWP-14S-W	14	22x1.5	
420		HD-MWP-16S-W	16	24x1.5		
		HD-MWP-20S-W	20	30x2		
		HD-MWP-25S-W	25	36x2		
			HD-MWP-30S-W	30	42x2	
			HD-MWP-38S-W	38	52x2	

HIGH PRESSURE - DIN 2353 connectors

DIN 2353 Eaton Walterscheid™

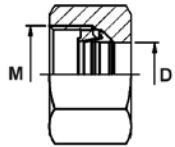
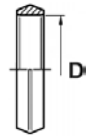
description	series	press. [bar]	code (galvanized steel)	D [mm]	M [mm]
<p>WALRing nut with cutting ring</p>   <p>MWR</p>	L	500	HD-MWR-06L-W	6	12x1.5
			HD-MWR-08L-W	8	14x1.5
			HD-MWR-10L-W	10	16x1.5
		400	HD-MWR-12L-W	12	18x1.5
			HD-MWR-15L-W	15	22x1.5
			HD-MWR-18L-W	18	26x1.5
		250	HD-MWR-22L-W	22	30x2
			HD-MWR-28L-W	28	36x2
			HD-MWR-35L-W	35	45x2
	S	800	HD-MWR-06S-W	6	14x1.5
			HD-MWR-08S-W	8	16x1.5
			HD-MWR-10S-W	10	18x1.5
		630	HD-MWR-12S-W	12	20x1.5
			HD-MWR-16S-W	16	24x1.5
			HD-MWR-20S-W	20	30x2
		420	HD-MWR-25S-W	25	36x2
			HD-MWR-30S-W	30	42x2
			HD-MWR-38S-W	38	52x2

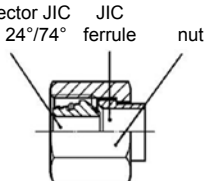
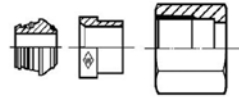
description	series	press. [bar]	code (galvanized steel)	D [mm]	M [mm]
<p>DIN2353/JIC connector + nut with metric thread + JIC ferrule o-ring seal</p> <p>connector JIC cone 24°/74° JIC ferrule nut</p>   <p>HJ</p>	L	500	HD-HJ-06L-W	6	12x1.5
			HD-HJ-08L-W	8	14x1.5
			HD-HJ-10L-W	10	16x1.5
		400	HD-HJ-12L-W	12	18x1.5
			HD-HJ-15L-W	15	22x1.5
			HD-HJ-18L-W	18	26x1.5
		250	HD-HJ-22L-W	22	30x2
			HD-HJ-28L-W	28	36x2
			HD-HJ-35L-W	35	45x2
	S	630	HD-HJ-42L-W	42	52x2
			HD-HJ-06S-W	6	14x1.5
			HD-HJ-08S-W	8	16x1.5
		400	HD-HJ-10S-W	10	18x1.5
			HD-HJ-12S-W	12	20x1.5
			HD-HJ-16S-W	16	24x1.5
		400	HD-HJ-20S-W	20	30x2
			HD-HJ-25S-W	25	36x2
			HD-HJ-30S-W	30	42x2
HD-HJ-38S-W	38	52x2			

HIGH PRESSURE - JIC 37° connectors

SAE fittings - J514 (JIC 37°)

Fittings manufactured according to SAE J514 (ISO 8434-2) standard are widely used in many branches of industry to connect steel pipes with outside diameter from 6 to 38 mm. Fittings according to SAE J514 can also be used to connect flexible hose assemblies. Widely used in hydraulic and pneumatic drive and control systems as well as in industrial applications.

Operation principle of JIC 37°

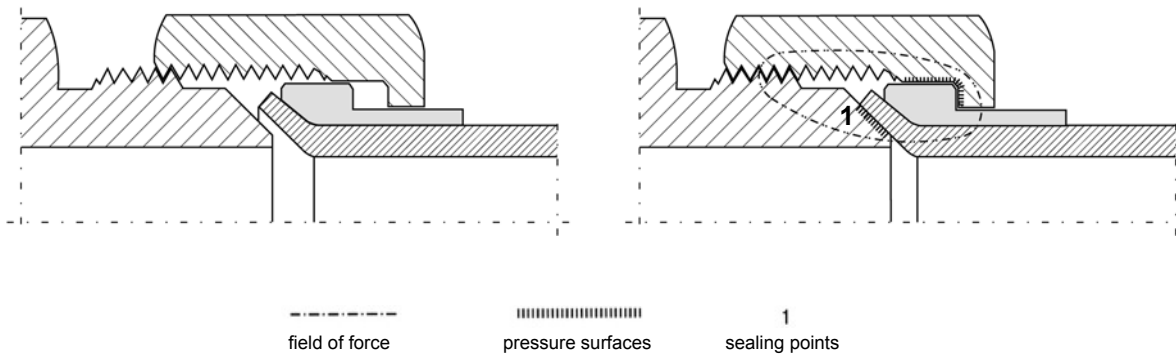

The pipes that are to be connected with JIC 37° fittings, must be flared with a flaring machine (hand tools must not be used). The connection of a fitting with a flared steel pipe with 74° angle cone ($37^\circ \times 2 = 74^\circ$) is obtained by a ferrule in a tightening nut. The flared 37° part of the pipe couples with the conical 37° part of the fitting body assuring metal to metal seal. Fittings with elastomeric sealing (O-ring) are available as well. The fittings according to JIC 37° may also be connected with JIC type fittings (e.g. TI-ZJW110, TI-ZJZ110) of flexible hydraulic hose assemblies.

Technical characteristics

Material:

Zinc-plated carbon steel, stainless steel (AISI 316Ti).

Working pressure:

Depends on the size and type of a fitting. The working pressure of the fitting given in the table is its max. working pressure (including temporary pressure build-up). Safety factor 4:1 (calculated for static pressure), for a connection of the fitting with a pipe or for fittings with elastomeric sealing. For fittings with taper thread or with metal to metal seal, the safety factor is 2.5:1.

Working temperature:

- for carbon steel fittings: from -20 C to +120 C
- for stainless steel fittings: from -60 C to +200 C

For temperatures above +100 C, the max. working pressure may require reduction.

Sealing:

NBR seals are used for carbon steel fittings, Viton (FPM) seals for stainless steel fittings as a standard. Working temperature range of the seals:

- NBR from -35°C up to +100°C,
- Viton (FPM) from -25°C up to +200°C.

Fluid being transferred:

Fittings according to JIC 37° can be used to transfer a wide range of fluids and gases. However, the compatibility of the medium with fitting material and seal type must be always checked. For all applications different from standard hydraulic oils, please contact TUBES INTERNATIONAL® Technical Department.

HIGH PRESSURE - JIC 37° connectors

Codes of connectors in the catalogue

Connectors are marked with special codes in our catalogue - they should be used when placing an order.

Code example:

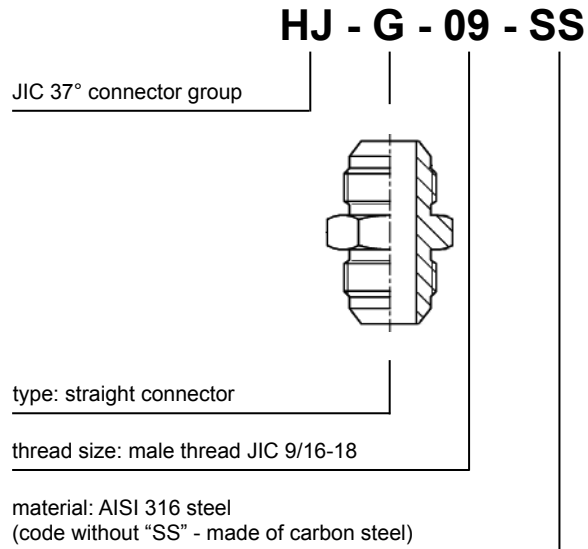

Code example:

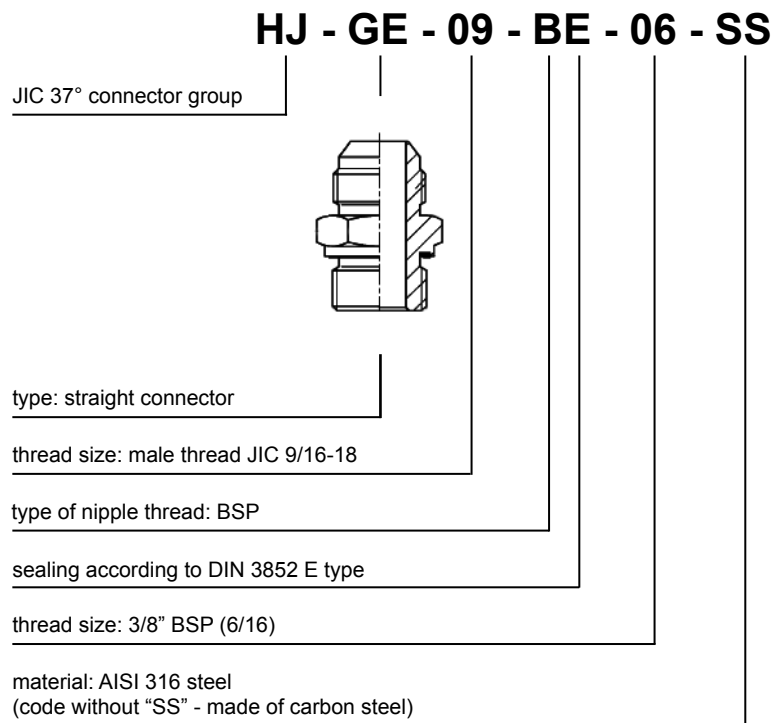

HIGH PRESSURE - JIC 37° connectors

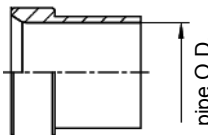
description	press. [bar]	code (carbon steel)	code (AISI 316)	pipe O.D.	
				[mm]	[inch]
Ferrule 	450	HJ-FM-06	HJ-FM-06-SS	6	-
		HJ-FC-04	HJ-FC-04-SS	-	1/4
		HJ-FM-08	HJ-FM-08-SS	8	-
			HJ-FC-05-SS	-	5/16
	350	HJ-FM-10	HJ-FM-10-SS	10	-
		HJ-FC-06	HJ-FC-06-SS	-	3/8
		HJ-FM-12	HJ-FM-12-SS	12	-
		HJ-FC-08	HJ-FC-08-SS	-	1/2
			HJ-FM-16	HJ-FM-16-SS	16
			HJ-FC-10-SS	-	5/8
		HJ-FM-20	HJ-FM-20-SS	20	-
		HJ-FC-12	HJ-FC-12-SS	-	3/4
	290	HJ-FM-25	HJ-FM-25-SS	25	-
	240	HJ-FC-16	HJ-FC-16-SS	-	1
		HJ-FM-32	HJ-FM-32-SS	32	-
		HJ-FC-20	HJ-FC-20-SS	-	1.1/4
			HJ-FM-38	HJ-FM-38-SS	38
		HJ-FC-24-SS	-	1.1/2	
	350	HJ-FM-14	HJ-FM-14-SS	14	-
		HJ-FM-15	HJ-FM-15-SS	15	-
HJ-FM-18		HJ-FM-18-SS	18	-	
240	HJ-FM-30	HJ-FM-30-SS	30	-	

FM
FC

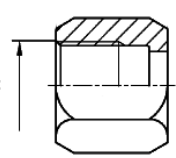
description	press. [bar]	code (carbon steel)	code (AISI 316)	pipe O.D.		JIC [UN-UNF]
				[mm]	[inch]	
Nut 	450	HJ-M-07	HJ-M-07-SS	6	1/4	7/16-20
		HJ-M-08	HJ-M-08-SS	8	5/16	1/2-20
	350	HJ-M-09	HJ-M-09-SS	10	3/8	9/16-18
		HJ-M-12	HJ-M-12-SS	12	1/2	3/4-16
		HJ-M-14	HJ-M-14-SS	14-15-16	5/8	7/8-14
			HJ-M-17	HJ-M-17-SS	18-20	3/4
	290	HJ-M-21	HJ-M-21-SS	25	1	1.5/16-12
	240	HJ-M-26	HJ-M-26-SS	30-32	1.1/4	1.5/8-12
		HJ-M-30	HJ-M-30-SS	38	1.1/2	1.7/8-12

M

Example of a set for JIC37° fitting connection with seamless hydraulic precision pipe

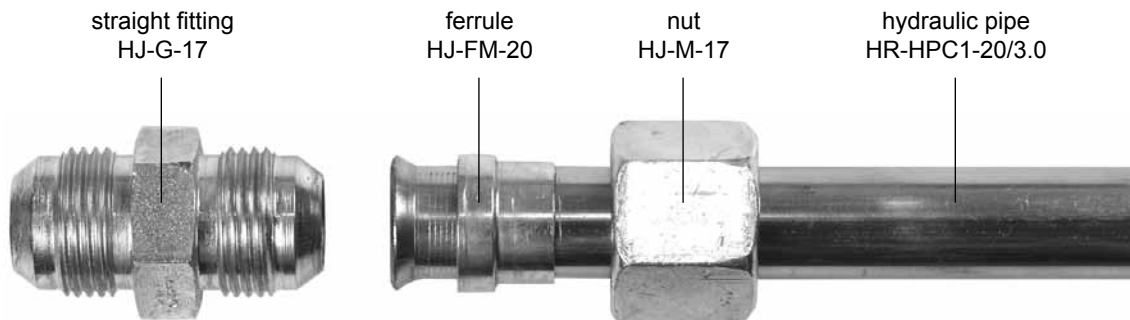

HIGH PRESSURE - JIC 37° connectors

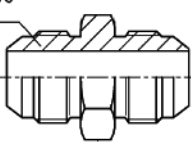
description	press. [bar]	code (carbon steel)	code (AISI 316)	pipe O.D.				JIC 37° [UN-UNF]	
				[mm]		[inch]		A	B
				A	B	A	B		
Straight connector 	450	HJ-G-07	HJ-G-07-SS	6	6	1/4	1/4	7/16-20	7/16-20
		HJ-G-08	HJ-G-08-SS	8	8	5/16	5/16	1/2-20	1/2-20
	350	HJ-G-09	HJ-G-09-SS	10	10	3/8	3/8	9/16-18	9/16-18
		HJ-G-12	HJ-G-12-SS	12	12	1/2	1/2	3/4-16	3/4-16
		HJ-G-14	HJ-G-14-SS	14-15-16	14-15-16	5/8	5/8	7/8-14	7/8-14
	290	HJ-G-17	HJ-G-17-SS	18-20	18-20	3/4	3/4	1.1/16-12	1.1/16-12
		HJ-G-21	HJ-G-21-SS	25	25	1	1	1.5/16-12	1.5/16-12
	240	HJ-G-26	HJ-G-26-SS	30-32	30-32	1.1/4	1.1/4	1.5/8-12	1.5/8-12
		HJ-G-30	HJ-G-30-SS	38	38	1.1/2	1.1/2	1.7/8-12	1.7/8-12
	350	HJ-GR-09-07	-	10	6	3/8	1/4	9/16-18	7/16-20
		HJ-GR-12-09	-	12	10	1/2	3/8	3/4-16	9/16-18
		HJ-GR-14-12	-	14-15-16	12	5/8	1/2	7/8-14	3/4-16
		HJ-GR-17-12	-	18-20	12	3/4	1/2	1.1/16-12	3/4-16
		HJ-GR-17-14	-	18-20	14-15-16	3/4	5/8	1.1/16-12	7/8-14
	290	HJ-GR-21-17	-	25	18-20	1	3/4	1.5/16-12	1.1/16-12

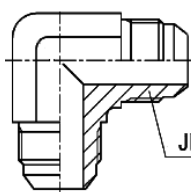
description	press. [bar]	code (carbon steel)	code (AISI 316)	pipe O.D.		JIC 37° [UN-UNF]
				[mm]	[inch]	
90° elbow connector 	450	HJ-W-07	HJ-W-07-SS	6	1/4	7/16-20
		HJ-W-08	HJ-W-08-SS	8	5/16	1/2-20
	350	HJ-W-09	HJ-W-09-SS	10	3/8	9/16-18
		HJ-W-12	HJ-W-12-SS	12	1/2	3/4-16
		HJ-W-14	HJ-W-14-SS	14-15-16	5/8	7/8-14
	290	HJ-W-17	HJ-W-17-SS	18-20	3/4	1.1/16-12
		HJ-W-21	HJ-W-21-SS	25	1	1.5/16-12
	240	HJ-W-26	HJ-W-26-SS	30-32	1.1/4	1.5/8-12
		HJ-W-30	HJ-W-30-SS	38	1.1/2	1.7/8-12

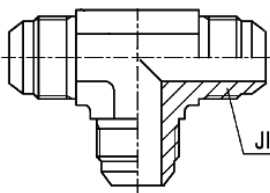
description	press. [bar]	code (carbon steel)	code (AISI 316)	pipe O.D.		JIC 37° [UN-UNF]
				[mm]	[inch]	
Tee connector 	450	HJ-T-07	HJ-T-07-SS	6	1/4	7/16-20
		HJ-T-08	HJ-T-08-SS	8	5/16	1/2-20
	350	HJ-T-09	HJ-T-09-SS	10	3/8	9/16-18
		HJ-T-12	HJ-T-12-SS	12	1/2	3/4-16
		HJ-T-14	HJ-T-14-SS	14-15-16	5/8	7/8-14
	290	HJ-T-17	HJ-T-17-SS	18-20	3/4	1.1/16-12
		HJ-T-21	HJ-T-21-SS	25	1	1.5/16-12
	240	HJ-T-26	HJ-T-26-SS	30-32	1.1/4	1.5/8-12
		HJ-T-30	HJ-T-30-SS	38	1.1/2	1.7/8-12

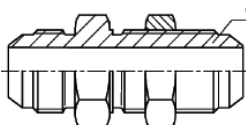
description	press. [bar]	code (carbon steel)	code (AISI 316)	pipe O.D.		JIC 37° [UN-UNF]
				[mm]	[inch]	
Straight bulkhead connector 	450	HJ-SV-07	HJ-SV-07-SS	6	1/4	7/16-20
		HJ-SV-08	HJ-SV-08-SS	8	5/16	1/2-20
	350	HJ-SV-09	HJ-SV-09-SS	10	3/8	9/16-18
		HJ-SV-12	HJ-SV-12-SS	12	1/2	3/4-16
		HJ-SV-14	HJ-SV-14-SS	14-15-16	5/8	7/8-14
	290	HJ-SV-17	HJ-SV-17-SS	18-20	3/4	1.1/16-12
		HJ-SV-21	HJ-SV-21-SS	25	1	1.5/16-12
	240	HJ-SV-26	HJ-SV-26-SS	30-32	1.1/4	1.5/8-12
		HJ-SV-30	HJ-SV-30-SS	38	1.1/2	1.7/8-12

HIGH PRESSURE - JIC 37° connectors

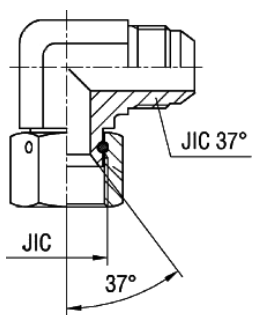
description	press. [bar]	code (carbon steel)	code (AISI 316)	pipe O.D.		JIC 37° [UN-UNF]
				[mm]	[inch]	
Adjustable 90° elbow connector  EVW	450	HJ-EVW-07	HJ-EVW-07-SS	6	1/4	7/16-20
		HJ-EVW-08	HJ-EVW-08-SS	8	5/16	1/2-20
	350	HJ-EVW-09	HJ-EVW-09-SS	10	3/8	9/16-18
		HJ-EVW-12	HJ-EVW-12-SS	12	1/2	3/4-16
		HJ-EVW-14	HJ-EVW-14-SS	14-15-16	5/8	7/8-14
		HJ-EVW-17	HJ-EVW-17-SS	18-20	3/4	1.1/16-12
	290	HJ-EVW-21	HJ-EVW-21-SS	25	1	1.5/16-12
	240	HJ-EVW-26	HJ-EVW-26-SS	30-32	1.1/4	1.5/8-12
		HJ-EVW-30	HJ-EVW-30-SS	38	1.1/2	1.7/8-12

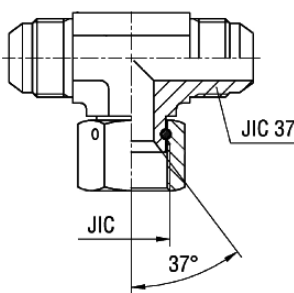
description	press. [bar]	code (carbon steel)	code (AISI 316)	pipe O.D.		JIC 37° [UN-UNF]
				[mm]	[inch]	
Adjustable tee connector  EVT	450	HJ-EVT-07	HJ-EVT-07-SS	6	1/4	7/16-20
		HJ-EVT-08	HJ-EVT-08-SS	8	5/16	1/2-20
	350	HJ-EVT-09	HJ-EVT-09-SS	10	3/8	9/16-18
		HJ-EVT-12	HJ-EVT-12-SS	12	1/2	3/4-16
		HJ-EVT-14	HJ-EVT-14-SS	14-15-16	5/8	7/8-14
		HJ-EVT-17	HJ-EVT-17-SS	18-20	3/4	1.1/16-12
	290	HJ-EVT-21	HJ-EVT-21-SS	25	1	1.5/16-12
	240	HJ-EVT-26	HJ-EVT-26-SS	30-32	1.1/4	1.5/8-12
		HJ-EVT-30	HJ-EVT-30-SS	38	1.1/2	1.7/8-12

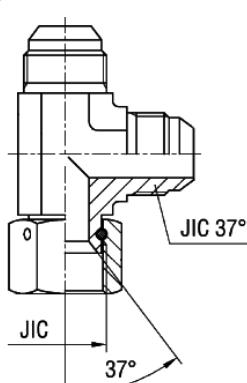
description	press. [bar]	code (carbon steel)	code (AISI 316)	pipe O.D.		JIC 37° [UN-UNF]
				[mm]	[inch]	
Adjustable tee connector (asymmetric)  EVL	450	HJ-EVL-07	HJ-EVL-07-SS	6	1/4	7/16-20
		HJ-EVL-08	HJ-EVL-08-SS	8	5/16	1/2-20
	350	HJ-EVL-09	HJ-EVL-09-SS	10	3/8	9/16-18
		HJ-EVL-12	HJ-EVL-12-SS	12	1/2	3/4-16
		HJ-EVL-14	HJ-EVL-14-SS	14-15-16	5/8	7/8-14
		HJ-EVL-17	HJ-EVL-17-SS	18-20	3/4	1.1/16-12
	290	HJ-EVL-21	HJ-EVL-21-SS	25	1	1.5/16-12
	240	HJ-EVL-26	HJ-EVL-26-SS	30-32	1.1/4	1.5/8-12
		HJ-EVL-30	HJ-EVL-30-SS	38	1.1/2	1.7/8-12

HIGH PRESSURE - JIC 37° connectors

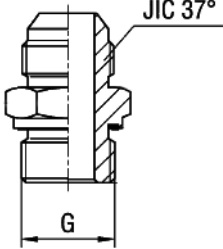
description	press. [bar]	code (carbon steel)	code (AISI 316)	pipe O.D.		JIC 37° [UN-UNF]	G [BSP]	
				[mm]	[inch]			
Straight nipple, BSP thread 	350	HJ-GE-07-BE-02	HJ-GE-07-BE-02-SS	6	1/4	7/16-20	1/8	
		HJ-GE-08-BE-02	HJ-GE-08-BE-02-SS	8	5/16	1/2-20	1/8	
		HJ-GE-09-BE-04	HJ-GE-09-BE-04-SS	10	3/8	9/16-18	1/4	
		HJ-GE-12-BE-06	HJ-GE-12-BE-06-SS	12	1/2	3/4-16	3/8	
		HJ-GE-14-BE-08	HJ-GE-14-BE-08-SS	14-15-16	5/8	7/8-14	1/2	
		HJ-GE-17-BE-12	HJ-GE-17-BE-12-SS	18-20	3/4	1.1/16-12	3/4	
	290	HJ-GE-21-BE-16	HJ-GE-21-BE-16-SS	25	1	1.5/16-12	1	
	240	HJ-GE-26-BE-20	HJ-GE-26-BE-20-SS	30-32	1.1/4	1.5/8-12	1.1/4	
		HJ-GE-30-BE-24	HJ-GE-30-BE-24-SS	38	1.1/2	1.7/8-12	1.1/2	
	350	HJ-GE-07-BE-04	HJ-GE-07-BE-04-SS	6	1/4	7/16-20	1/4	
		HJ-GE-07-BE-06	-	6	1/4	7/16-20	3/8	
		HJ-GE-07-BE-08	HJ-GE-07-BE-08-SS	6	1/4	7/16-20	1/2	
		HJ-GE-08-BE-04	HJ-GE-08-BE-04-SS	8	5/16	1/2-20	1/4	
		HJ-GE-08-BE-06	HJ-GE-08-BE-06-SS	8	5/16	1/2-20	3/8	
		HJ-GE-09-BE-02	HJ-GE-09-BE-02-SS	10	3/8	9/16-18	1/8	
		HJ-GE-09-BE-06	HJ-GE-09-BE-06-SS	10	3/8	9/16-18	3/8	
		HJ-GE-09-BE-08	HJ-GE-09-BE-08-SS	10	3/8	9/16-18	1/2	
		HJ-GE-12-BE-04	HJ-GE-12-BE-04-SS	12	1/2	3/4-16	1/4	
		HJ-GE-12-BE-08	HJ-GE-12-BE-08-SS	12	1/2	3/4-16	1/2	
		HJ-GE-12-BE-12	HJ-GE-12-BE-12-SS	12	1/2	3/4-16	3/4	
		HJ-GE-14-BE-06	HJ-GE-14-BE-06-SS	14-15-16	5/8	7/8-14	3/8	
		HJ-GE-14-BE-12	HJ-GE-14-BE-12-SS	14-15-16	5/8	7/8-14	3/4	
		HJ-GE-17-BE-06	-	18-20	3/4	1.1/16-12	3/8	
		HJ-GE-17-BE-08	HJ-GE-17-BE-08-SS	18-20	3/4	1.1/16-12	1/2	
		290	HJ-GE-17-BE-16	HJ-GE-17-BE-16-SS	18-20	3/4	1.1/16-12	1
			HJ-GE-21-BE-12	HJ-GE-21-BE-12-SS	25	1	1.5/16-12	3/4
		240	HJ-GE-21-BE-20	HJ-GE-21-BE-20-SS	25	1	1.5/16-12	1.1/4
	HJ-GE-26-BE-16		HJ-GE-26-BE-16-SS	30-32	1.1/4	1.5/8-12	1	
	HJ-GE-26-BE-24		HJ-GE-26-BE-24-SS	30-32	1.1/4	1.5/8-12	1.1/2	
	HJ-GE-30-BE-20		HJ-GE-30-BE-20-SS	38	1.1/2	1.7/8-12	1.1/4	

GE - BE

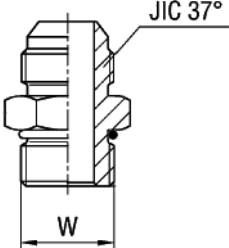
description	press. [bar]	code (carbon steel)	code (AISI 316)	pipe O.D.		JIC 37° [UN-UNF]	W [UN-UNF]	
				[mm]	[inch]			
Straight nipple, UN-UNF thread 	400	HJ-GE-07-UN-07	HJ-GE-07-UN-07-SS	6	1/4	7/16-20	7/16-20	
		HJ-GE-08-UN-08	HJ-GE-08-UN-08-SS	8	5/16	1/2-20	1/2-20	
	350	HJ-GE-09-UN-09	HJ-GE-09-UN-09-SS	10	3/8	9/16-18	9/16-18	
		HJ-GE-12-UN-12	HJ-GE-12-UN-12-SS	12	1/2	3/4-16	3/4-16	
		HJ-GE-14-UN-14	HJ-GE-14-UN-14-SS	14-15-16	5/8	7/8-14	7/8-14	
		HJ-GE-17-UN-17	HJ-GE-17-UN-17-SS	18-20	3/4	1.1/16-12	1.1/16-12	
	290	HJ-GE-21-UN-21	HJ-GE-21-UN-21-SS	25	1	1.5/16-12	1.5/16-12	
	240	HJ-GE-26-UN-26	-	30-32	1.1/4	1.5/8-12	1.5/8-12	
		HJ-GE-30-UN-30	-	38	1.1/2	1.7/8-12	1.7/8-12	
	350	400	HJ-GE-07-UN-08	-	6	1/4	7/16-20	1/2-20
			HJ-GE-07-UN-09	-	6	1/4	7/16-20	9/16-18
		HJ-GE-07-UN-12	-	6	1/4	7/16-20	3/4-16	
		HJ-GE-08-UN-09	-	8	5/16	1/2-20	9/16-18	
		HJ-GE-09-UN-07	-	10	3/8	9/16-18	7/16-20	
		HJ-GE-09-UN-08	-	10	3/8	9/16-18	1/2-20	
		HJ-GE-09-UN-12	-	10	3/8	9/16-18	3/4-16	
		HJ-GE-09-UN-14	-	10	3/8	9/16-18	7/8-14	
		HJ-GE-12-UN-09	-	12	1/2	3/4-16	9/16-18	
		HJ-GE-12-UN-14	-	12	1/2	3/4-16	7/8-14	
		HJ-GE-12-UN-17	-	12	1/2	3/4-16	1.1/16-12	
		HJ-GE-14-UN-12	-	14-15-16	5/8	7/8-14	3/4-16	
		HJ-GE-14-UN-17	-	14-15-16	5/8	7/8-14	1.1/16-12	
		HJ-GE-17-UN-12	-	18-20	3/4	1.1/16-12	3/4-16	
		HJ-GE-17-UN-14	-	18-20	3/4	1.1/16-12	7/8-14	
		290	HJ-GE-17-UN-21	-	18-20	3/4	1.1/16-12	1.5/16-12
			HJ-GE-21-UN-14	-	25	1	1.5/16-12	7/8-14
			HJ-GE-21-UN-17	-	25	1	1.5/16-12	1.1/16-12
	240	HJ-GE-21-UN-26	-	25	1	1.5/16-12	1.5/8-12	
		HJ-GE-26-UN-21	-	30-32	1.1/4	1.5/8-12	1.5/16-12	
	HJ-GE-30-UN-26	-	38	1.1/2	1.7/8-12	1.5/8-12		

GE - UN

HIGH PRESSURE - JIC 37° connectors

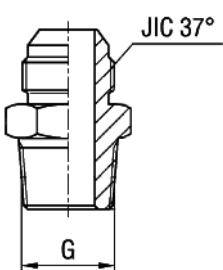
description	press. [bar]	code (carbon steel)	code (AISI 316)	pipe O.D.		JIC 37° [UN-UNF]	G [BSPT]
				[mm]	[inch]		
Straight nipple, BSPT (taper) thread 	350	HJ-GE-07-BT-02	HJ-GE-07-BT-02-SS	6	1/4	7/16-20	1/8
		HJ-GE-08-BT-02	HJ-GE-08-BT-02-SS	8	5/16	1/2-20	1/8
		HJ-GE-09-BT-04	HJ-GE-09-BT-04-SS	10	3/8	9/16-18	1/4
		HJ-GE-12-BT-06	HJ-GE-12-BT-06-SS	12	1/2	3/4-16	3/8
		HJ-GE-14-BT-08	HJ-GE-14-BT-08-SS	14-15-16	5/8	7/8-14	1/2
	HJ-GE-17-BT-12	HJ-GE-17-BT-12-SS	18-20	3/4	1.1/16-12	3/4	
	290	HJ-GE-21-BT-16	HJ-GE-21-BT-16-SS	25	1	1.5/16-12	1
	240	HJ-GE-26-BT-20	HJ-GE-26-BT-20-SS	30-32	1.1/4	1.5/8-12	1.1/4
		HJ-GE-30-BT-24	HJ-GE-30-BT-24-SS	38	1.1/2	1.7/8-12	1.1/2
	350	HJ-GE-07-BT-04	HJ-GE-07-BT-04-SS	6	1/4	7/16-20	1/4
		HJ-GE-08-BT-04	HJ-GE-08-BT-04-SS	8	5/16	1/2-20	1/4
		HJ-GE-09-BT-02	HJ-GE-09-BT-02-SS	10	3/8	9/16-18	1/8
		HJ-GE-09-BT-06	HJ-GE-09-BT-06-SS	10	3/8	9/16-18	3/8
		HJ-GE-09-BT-08	HJ-GE-09-BT-08-SS	10	3/8	9/16-18	1/2
		HJ-GE-12-BT-04	HJ-GE-12-BT-04-SS	12	1/2	3/4-16	1/4
		HJ-GE-12-BT-08	HJ-GE-12-BT-08-SS	12	1/2	3/4-16	1/2
		HJ-GE-12-BT-12	HJ-GE-12-BT-12-SS	12	1/2	3/4-16	3/4
		HJ-GE-14-BT-06	HJ-GE-14-BT-06-SS	14-15-16	5/8	7/8-14	3/8
		HJ-GE-14-BT-12	HJ-GE-14-BT-12-SS	14-15-16	5/8	7/8-14	3/4
	HJ-GE-17-BT-08	HJ-GE-17-BT-08-SS	18-20	3/4	1.1/16-12	1/2	
	290	HJ-GE-17-BT-16	HJ-GE-17-BT-16-SS	18-20	3/4	1.1/16-12	1
		HJ-GE-21-BT-12	HJ-GE-21-BT-12-SS	25	1	1.5/16-12	3/4
	240	HJ-GE-26-BT-16	HJ-GE-26-BT-16-SS	30-32	1.1/4	1.5/8-12	1
		HJ-GE-30-BT-20	HJ-GE-30-BT-20-SS	38	1.1/2	1.7/8-12	1.1/4

GE - BT

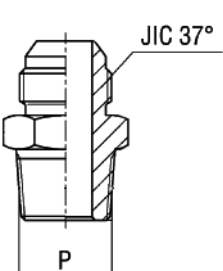
description	press. [bar]	code (carbon steel)	code (AISI 316)	pipe O.D.		JIC 37° [UN-UNF]	P [NPT]
				[mm]	[inch]		
Straight nipple, NPT (taper) thread 	350	HJ-GE-07-NT-02	HJ-GE-07-NT-02-SS	6	1/4	7/16-20	1/8
		HJ-GE-08-NT-02	HJ-GE-08-NT-02-SS	8	5/16	1/2-20	1/8
		HJ-GE-09-NT-04	HJ-GE-09-NT-04-SS	10	3/8	9/16-18	1/4
		HJ-GE-12-NT-06	HJ-GE-12-NT-06-SS	12	1/2	3/4-16	3/8
		HJ-GE-14-NT-08	HJ-GE-14-NT-08-SS	14-15-16	5/8	7/8-14	1/2
	HJ-GE-17-NT-12	HJ-GE-17-NT-12-SS	18-20	3/4	1.1/16-12	3/4	
	290	HJ-GE-21-NT-16	HJ-GE-21-NT-16-SS	25	1	1.5/16-12	1
	240	HJ-GE-26-NT-20	HJ-GE-26-NT-20-SS	30-32	1.1/4	1.5/8-12	1.1/4
		HJ-GE-30-NT-24	HJ-GE-30-NT-24-SS	38	1.1/2	1.7/8-12	1.1/2
	350	HJ-GE-07-NT-04	HJ-GE-07-NT-04-SS	6	1/4	7/16-20	1/4
		HJ-GE-07-NT-06	HJ-GE-07-NT-06-SS	6	1/4	7/16-20	3/8
		HJ-GE-07-NT-08	HJ-GE-07-NT-08-SS	6	1/4	7/16-20	1/2
		HJ-GE-08-NT-04	HJ-GE-08-NT-04-SS	8	5/16	1/2-20	1/4
		HJ-GE-09-NT-02	HJ-GE-09-NT-02-SS	10	3/8	9/16-18	1/8
		HJ-GE-09-NT-06	HJ-GE-09-NT-06-SS	10	3/8	9/16-18	3/8
		HJ-GE-09-NT-08	HJ-GE-09-NT-08-SS	10	3/8	9/16-18	1/2
		HJ-GE-12-NT-04	HJ-GE-12-NT-04-SS	12	1/2	3/4-16	1/4
		HJ-GE-12-NT-08	HJ-GE-12-NT-08-SS	12	1/2	3/4-16	1/2
		HJ-GE-12-NT-12	HJ-GE-12-NT-12-SS	12	1/2	3/4-16	3/4
	HJ-GE-07-NT-21	HJ-GE-07-NT-21-SS	14-15-16	5/8	7/8-14	3/8	
	HJ-GE-14-NT-12	HJ-GE-14-NT-12-SS	14-15-16	5/8	7/8-14	3/4	
	HJ-GE-17-NT-08	HJ-GE-17-NT-08-SS	18-20	3/4	1.1/16-12	1/2	
	290	HJ-GE-17-NT-16	HJ-GE-17-NT-16-SS	18-20	3/4	1.1/16-12	1
		HJ-GE-21-NT-12	HJ-GE-21-NT-12-SS	25	1	1.5/16-12	3/4
	240	HJ-GE-26-NT-16	HJ-GE-26-NT-16-SS	30-32	1.1/4	1.5/8-12	1
		HJ-GE-30-NT-20	HJ-GE-30-NT-20-SS	38	1.1/2	1.7/8-12	1.1/4

GE - NT

HIGH PRESSURE - JIC 37° connectors

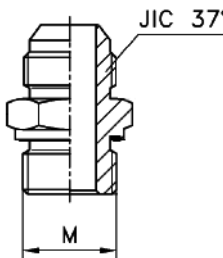
description	press. [bar]	code (carbon steel)	code (AISI 316)	pipe O.D.		JIC 37° [UN-UNF]	M [mm]
				[mm]	[inch]		
Straight nipple, metric thread 	350	HJ-GE-07-ME-10	-	6	1/4	7/16-20	10x1
		HJ-GE-08-ME-12	-	8	5/16	1/2-20	12x1.5
		HJ-GE-09-ME-14	-	10	3/8	9/16-18	14x1.5
		HJ-GE-12-ME-16	-	12	1/2	3/4-16	16x1.5
		HJ-GE-14-ME-22	-	14-15-16	5/8	7/8-14	22x1.5
		HJ-GE-17-ME-27	-	18-20	3/4	1.1/16-12	27x2
	290	HJ-GE-21-ME-33	-	25	1	1.5/16-12	33x2
	240	HJ-GE-26-ME-42	-	30-32	1.1/4	1.5/8-12	42x2
		HJ-GE-30-ME-48	-	38	1.1/2	1.7/8-12	48x2
	350	HJ-GE-07-ME-12	-	6	1/4	7/16-20	12x1.5
		HJ-GE-08-ME-10	-	8	5/16	1/2-20	10x1
		HJ-GE-08-ME-14	-	8	5/16	1/2-20	14x1.5
		HJ-GE-09-ME-16	-	10	3/8	9/16-18	16x1.5
		HJ-GE-12-ME-14	-	12	1/2	3/4-16	14x1.5
		HJ-GE-12-ME-18	-	12	1/2	3/4-16	18x1.5
		HJ-GE-14-ME-18	-	14-15-16	5/8	7/8-14	18x1.5
		HJ-GE-14-ME-20	-	14-15-16	5/8	7/8-14	20x1.5
	HJ-GE-17-ME-22	-	18-20	3/4	1.1/16-12	22x1.5	
HJ-GE-21-ME-27	-	25	1	1.5/16-12	27x2		

GE - ME

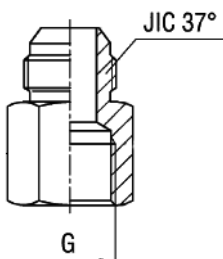
description	press. [bar]	code (carbon steel)	code (AISI 316)	pipe O.D.		JIC 37° [UN-UNF]	G [BSP]
				[mm]	[inch]		
Straight fitting, BSP female thread 	350	HJ-GAI-07-B-02	HJ-GAI-07-B-02-SS	6	1/4	7/16-20	1/8
		HJ-GAI-08-B-02	HJ-GAI-08-B-02-SS	8	5/16	1/2-20	1/8
		HJ-GAI-09-B-04	HJ-GAI-09-B-04-SS	10	3/8	9/16-18	1/4
		HJ-GAI-12-B-06	HJ-GAI-12-B-06-SS	12	1/2	3/4-16	3/8
		HJ-GAI-14-B-08	HJ-GAI-14-B-08-SS	14-15-16	5/8	7/8-14	1/2
		HJ-GAI-17-B-12	HJ-GAI-17-B-12-SS	18-20	3/4	1.1/16-12	3/4
	290	HJ-GAI-21-B-16	HJ-GAI-21-B-16-SS	25	1	1.5/16-12	1
	240	HJ-GAI-26-B-20	HJ-GAI-26-B-20-SS	30-32	1.1/4	1.5/8-12	1.1/4
		HJ-GAI-30-B-24	HJ-GAI-30-B-24-SS	38	1.1/2	1.7/8-12	1.1/2
	350	HJ-GAI-07-B-04	HJ-GAI-07-B-04-SS	6	1/4	7/16-20	1/4
		HJ-GAI-08-B-04	HJ-GAI-08-B-04-SS	8	5/16	1/2-20	1/4
		HJ-GAI-09-B-06	HJ-GAI-09-B-06-SS	10	3/8	9/16-18	3/8
		HJ-GAI-09-B-08	-	10	3/8	9/16-18	1/2
		HJ-GAI-12-B-04	-	12	1/2	3/4-16	1/4
		HJ-GAI-12-B-08	HJ-GAI-12-B-08-SS	12	1/2	3/4-16	1/2
		HJ-GAI-17-B-08	-	18-20	3/4	1.1/16-12	1/2
		HJ-GAI-26-B-16	-	30-32	1.1/4	1.5/8-12	1
	HJ-GAI-30-B-20	-	38	1.1/2	1.7/8-12	1.1/4	

GAI - B

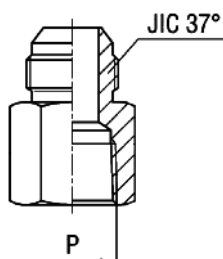
description	press. [bar]	code (carbon steel)	code (AISI 316)	pipe O.D.		JIC 37° [UN-UNF]	P [NPT]
				[mm]	[inch]		
Straight fitting, NPT female thread 	350	HJ-GAI-07-N-02	-	6	1/4	7/16-20	1/8
		HJ-GAI-08-N-02	-	8	5/16	1/2-20	1/8
		HJ-GAI-09-N-04	-	10	3/8	9/16-18	1/4
		HJ-GAI-12-N-06	-	12	1/2	3/4-16	3/8
		HJ-GAI-14-N-08	-	14-15-16	5/8	7/8-14	1/2
		HJ-GAI-17-N-12	-	18-20	3/4	1.1/16-12	3/4
	290	HJ-GAI-21-N-16	-	25	1	1.5/16-12	1
	240	HJ-GAI-26-N-20	-	30-32	1.1/4	1.5/8-12	1.1/4
		HJ-GAI-30-N-24	-	38	1.1/2	1.7/8-12	1.1/2
	350	HJ-GAI-07-N-04	-	6	1/4	7/16-20	1/4
		HJ-GAI-08-N-04	-	8	5/16	1/2-20	1/4
		HJ-GAI-09-N-06	-	10	3/8	9/16-18	3/8
		HJ-GAI-12-N-04	-	12	1/2	3/4-16	1/4
		HJ-GAI-12-N-08	-	12	1/2	3/4-16	1/2
HJ-GAI-17-N-08		-	18-20	3/4	1.1/16-12	1/2	

GAI - N

HIGH PRESSURE - JIC 37° connectors

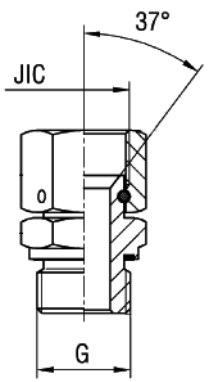
description	press. [bar]	code (carbon steel)	code (AISI 316)	pipe O.D.		JIC 37° [UN-UNF]	G [BSP]	
				[mm]	[inch]			
Straight fitting, BSP male thread 	350	HJ-EVGE-07-BE-02	HJ-EVGE-07-BE-02-SS	6	1/4	7/16-20	1/8	
		HJ-EVGE-08-BE-02	HJ-EVGE-08-BE-02-SS	8	5/16	1/2-20	1/8	
		HJ-EVGE-09-BE-04	HJ-EVGE-09-BE-04-SS	10	3/8	9/16-18	1/4	
		HJ-EVGE-12-BE-06	HJ-EVGE-12-BE-06-SS	12	1/2	3/4-16	3/8	
		HJ-EVGE-14-BE-08	HJ-EVGE-14-BE-08-SS	14-15-16	5/8	7/8-14	1/2	
	HJ-EVGE-17-BE-12	HJ-EVGE-17-BE-12-SS	18-20	3/4	1.1/16-12	3/4		
	290	HJ-EVGE-21-BE-16	HJ-EVGE-21-BE-16-SS	25	1	1.5/16-12	1	
	240	HJ-EVGE-26-BE-20	HJ-EVGE-26-BE-20-SS	30-32	1.1/4	1.5/8-12	1.1/4	
		HJ-EVGE-30-BE-24	HJ-EVGE-30-BE-24-SS	38	1.1/2	1.7/8-12	1.1/2	
	350	HJ-EVGE-07-BE-04	HJ-EVGE-07-BE-04-SS	6	1/4	7/16-20	1/4	
		HJ-EVGE-07-BE-06	-	6	1/4	7/16-20	3/8	
		HJ-EVGE-08-BE-04	HJ-EVGE-08-BE-04-SS	8	5/16	1/2-20	1/4	
		HJ-EVGE-08-BE-06	HJ-EVGE-08-BE-06-SS	8	5/16	1/2-20	3/8	
		HJ-EVGE-09-BE-06	HJ-EVGE-09-BE-06-SS	10	3/8	9/16-18	3/8	
		HJ-EVGE-09-BE-08	HJ-EVGE-09-BE-08-SS	10	3/8	9/16-18	1/2	
		HJ-EVGE-12-BE-04	HJ-EVGE-12-BE-04-SS	12	1/2	3/4-16	1/4	
		HJ-EVGE-12-BE-08	HJ-EVGE-12-BE-08-SS	12	1/2	3/4-16	1/2	
		HJ-EVGE-14-BE-06	HJ-EVGE-14-BE-06-SS	14-15-16	5/8	7/8-14	3/8	
		HJ-EVGE-14-BE-12	HJ-EVGE-14-BE-12-SS	14-15-16	5/8	7/8-14	3/4	
	290	HJ-EVGE-17-BE-08	HJ-EVGE-17-BE-08-SS	18-20	3/4	1.1/16-12	1/2	
		HJ-EVGE-17-BE-16	HJ-EVGE-17-BE-16-SS	18-20	3/4	1.1/16-12	1	
	240	HJ-EVGE-21-BE-12	HJ-EVGE-21-BE-12-SS	25	1	1.5/16-12	3/4	
		HJ-EVGE-21-BE-20	-	25	1	1.5/16-12	1.1/4	
		HJ-EVGE-26-BE-16	HJ-EVGE-26-BE-16-SS	30-32	1.1/4	1.5/8-12	1	
			HJ-EVGE-30-BE-20	HJ-EVGE-30-BE-20-SS	38	1.1/2	1.7/8-12	1.1/4

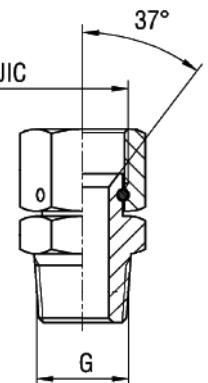
description	press. [bar]	code (carbon steel)	code (AISI 316)	JIC 37 [UN-UNF]	G [BSPT]
Straight fitting, BSPT male thread 	350	HJ-EVGE-07-BT-02	-	7/16-20	1/8
		HJ-EVGE-08-BT-02	-	1/2-20	1/8
		HJ-EVGE-09-BT-04	-	9/16-18	1/4
		HJ-EVGE-12-BT-06	-	3/4-16	3/8
		HJ-EVGE-14-BT-08	-	7/8-14	1/2
		HJ-EVGE-17-BT-12	-	1.1/16-12	3/4
	290	HJ-EVGE-21-BT-16	-	1.5/16-12	1
	240	HJ-EVGE-26-BT-20	-	1.5/8-12	1.1/4
		HJ-EVGE-30-BT-24	-	1.7/8-12	1.1/2
	350	HJ-EVGE-07-BT-04	-	7/16-20	1/4
		HJ-EVGE-08-BT-04	-	1/2-20	1/4
		HJ-EVGE-09-BT-06	-	9/16-18	3/8
		HJ-EVGE-12-BT-04	-	3/4-16	1/4
		HJ-EVGE-12-BT-08	-	3/4-16	1/2
		HJ-EVGE-14-BT-06	-	7/8-14	3/8
	290	HJ-EVGE-14-BT-12	-	7/8-14	3/4
		HJ-EVGE-17-BT-08	-	1.1/16-12	1/2
		HJ-EVGE-17-BT-16	-	1.1/16-12	1
			HJ-EVGE-21-BT-12	-	1.5/16-12

HIGH PRESSURE - JIC 37° connectors

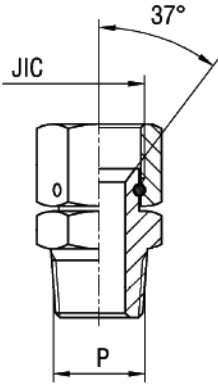
description	press. [bar]	code (carbon steel)	code (AISI 316)	JIC 37°	P
				[UN-UNF]	[NPT]
Straight fitting, NPT thread 	350	HJ-EVGE-07-NT-02	HJ-EVGE-07-NT-02-SS	7/16-20	1/8
		HJ-EVGE-08-NT-02	HJ-EVGE-08-NT-02-SS	1/2-20	1/8
		HJ-EVGE-09-NT-04	HJ-EVGE-09-NT-04-SS	9/16-18	1/4
		HJ-EVGE-12-NT-06	HJ-EVGE-12-NT-06-SS	3/4-16	3/8
		HJ-EVGE-14-NT-08	HJ-EVGE-14-NT-08-SS	7/8-14	1/2
	HJ-EVGE-17-NT-12	HJ-EVGE-17-NT-12-SS	1.1/16-12	3/4	
	290	HJ-EVGE-21-NT-16	HJ-EVGE-21-NT-16-SS	1.5/16-12	1
	240	HJ-EVGE-26-NT-20	HJ-EVGE-26-NT-20-SS	1.5/8-12	1.1/4
		HJ-EVGE-30-NT-24	HJ-EVGE-30-NT-24-SS	1.7/8-12	1.1/2
	350	HJ-EVGE-07-NT-04	HJ-EVGE-07-NT-04-SS	7/16-20	1/4
		HJ-EVGE-08-NT-04	HJ-EVGE-08-NT-04-SS	1/2-20	1/4
		HJ-EVGE-09-NT-02	HJ-EVGE-09-NT-02-SS	9/16-18	1/8
		HJ-EVGE-09-NT-06	HJ-EVGE-09-NT-06-SS	9/16-18	3/8
		HJ-EVGE-09-NT-08	HJ-EVGE-09-NT-08-SS	9/16-18	1/2
		HJ-EVGE-12-NT-04	HJ-EVGE-12-NT-04-SS	3/4-16	1/4
		HJ-EVGE-12-NT-08	HJ-EVGE-12-NT-08-SS	3/4-16	1/2
		HJ-EVGE-12-NT-12	HJ-EVGE-12-NT-12-SS	3/4-16	3/4
		HJ-EVGE-14-NT-06	HJ-EVGE-14-NT-06-SS	7/8-14	3/8
		HJ-EVGE-14-NT-12	HJ-EVGE-14-NT-12-SS	7/8-14	3/4
		HJ-EVGE-17-NT-08	HJ-EVGE-17-NT-08-SS	1.1/16-12	1/2
	290	HJ-EVGE-21-NT-12	HJ-EVGE-21-NT-12-SS	1.5/16-12	3/4
	240	HJ-EVGE-26-NT-16	HJ-EVGE-26-NT-16-SS	1.5/8-12	1

EVGE - NT

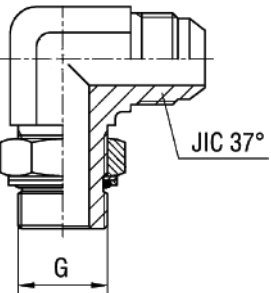
description	press. [bar]	code (carbon steel)	code (AISI 316)	pipe O.D.		JIC 37° [UN-UNF]	G [BSP]
				[mm]	[inch]		
Adjustable 90° elbow nipple, BSP thread, ISO 6199-G seal 	350	HJ-WE-07-BG-02	HJ-WE-07-BG-02-SS	6	1/4	7/16-20	1/8
	315	HJ-WE-08-BG-04	HJ-WE-08-BG-04-SS	8	5/16	1/2-20	1/4
		HJ-WE-09-BG-04	HJ-WE-09-BG-04-SS	10	3/8	9/16-18	1/4
	250	HJ-WE-12-BG-06	HJ-WE-12-BG-06-SS	12	1/2	3/4-16	3/8
		HJ-WE-14-BG-08	HJ-WE-14-BG-08-SS	14-15-16	5/8	7/8-14	1/2
		HJ-WE-17-BG-12	HJ-WE-17-BG-12-SS	18-20	3/4	1.1/16-12	3/4
	200	HJ-WE-21-BG-16	HJ-WE-21-BG-16-SS	25	1	1.5/16-12	1
		HJ-WE-26-BG-20	HJ-WE-26-BG-20-SS	30-32	1.1/4	1.5/8-12	1.1/4
	160	HJ-WE-30-BG-24	HJ-WE-30-BG-24-SS	38	1.1/2	1.7/8-12	1.1/2
	315	HJ-WE-07-BG-04	HJ-WE-07-BG-04-SS	6	1/4	7/16-20	1/4
	250	HJ-WE-07-BG-06	-	6	1/4	7/16-20	3/8
		HJ-WE-07-BG-08	-	6	1/4	7/16-20	1/2
	350	HJ-WE-08-BG-02	-	8	5/16	1/2-20	1/8
		HJ-WE-08-BG-06	-	8	5/16	1/2-20	3/8
	250	HJ-WE-09-BG-06	HJ-WE-09-BG-06-SS	10	3/8	9/16-18	3/8
		HJ-WE-09-BG-08	HJ-WE-09-BG-08-SS	10	3/8	9/16-18	1/2
		HJ-WE-12-BG-04	-	12	1/2	3/4-16	1/4
	250	HJ-WE-12-BG-08	HJ-WE-12-BG-08-SS	12	1/2	3/4-16	1/2
		HJ-WE-12-BG-12	-	12	1/2	3/4-16	3/4
		HJ-WE-14-BG-06	-	14-15-16	5/8	7/8-14	3/8
		HJ-WE-14-BG-12	-	14-15-16	5/8	7/8-14	3/4
		HJ-WE-17-BG-08	HJ-WE-17-BG-08-SS	18-20	3/4	1.1/16-12	1/2
	200	HJ-WE-17-BG-16	-	18-20	3/4	1.1/16-12	1
	250	HJ-WE-21-BG-12	-	25	1	1.5/16-12	3/4
200	HJ-WE-21-BG-20	-	25	1	1.5/16-12	1.1/4	
	HJ-WE-26-BG-16	-	30-32	1.1/4	1.5/8-12	1	
	HJ-WE-30-BG-20	-	38	1.1/2	1.7/8-12	1.1/4	

WE - BG

HIGH PRESSURE - JIC 37° connectors

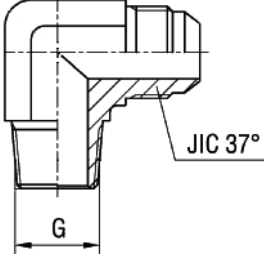
description	press. [bar]	code (carbon steel)	code (AISI 316)	pipe O.D.		JIC 37° [UN-UNF]	G [BSPT]
				[mm]	[inch]		
90° elbow nipple, BSPT (taper) thread 	350	HJ-WE-07-BT-02	HJ-WE-07-BT-02-SS	6	1/4	7/16-20	1/8
		HJ-WE-08-BT-02	HJ-WE-08-BT-02-SS	8	5/16	1/2-20	1/8
		HJ-WE-09-BT-04	HJ-WE-09-BT-04-SS	10	3/8	9/16-18	1/4
		HJ-WE-12-BT-06	HJ-WE-12-BT-06-SS	12	1/2	3/4-16	3/8
		HJ-WE-14-BT-08	HJ-WE-14-BT-08-SS	14-15-16	5/8	7/8-14	1/2
		HJ-WE-17-BT-12	HJ-WE-17-BT-12-SS	18-20	3/4	1.1/16-12	3/4
	290	HJ-WE-21-BT-16	HJ-WE-21-BT-16-SS	25	1	1.5/16-12	1
	240	HJ-WE-26-BT-20	HJ-WE-26-BT-20-SS	30-32	1.1/4	1.5/8-12	1.1/4
		HJ-WE-30-BT-24	HJ-WE-30-BT-24-SS	38	1.1/2	1.7/8-12	1.1/2
	350	HJ-WE-07-BT-04	HJ-WE-07-BT-04-SS	6	1/4	7/16-20	1/4
		HJ-WE-08-BT-04	HJ-WE-08-BT-04-SS	8	5/16	1/2-20	1/4
		HJ-WE-09-BT-02	HJ-WE-09-BT-02-SS	10	3/8	9/16-18	1/8
		HJ-WE-09-BT-06	HJ-WE-09-BT-06-SS	10	3/8	9/16-18	3/8
		HJ-WE-09-BT-08	HJ-WE-09-BT-08-SS	10	3/8	9/16-18	1/2
		HJ-WE-12-BT-04	HJ-WE-12-BT-04-SS	12	1/2	3/4-16	1/4
		HJ-WE-12-BT-08	HJ-WE-12-BT-08-SS	12	1/2	3/4-16	1/2
		HJ-WE-12-BT-12	-	12	1/2	3/4-16	3/4
		HJ-WE-14-BT-06	HJ-WE-14-BT-06-SS	14-15-16	5/8	7/8-14	3/8
		HJ-WE-14-BT-12	HJ-WE-14-BT-12-SS	14-15-16	5/8	7/8-14	3/4
	HJ-WE-17-BT-08	HJ-WE-17-BT-08-SS	18-20	3/4	1.1/16-12	1/2	
	290	HJ-WE-17-BT-16	HJ-WE-17-BT-16-SS	18-20	3/4	1.1/16-12	1
		HJ-WE-21-BT-12	HJ-WE-21-BT-12-SS	25	1	1.5/16-12	3/4
	240	HJ-WE-26-BT-16	HJ-WE-26-BT-16-SS	30-32	1.1/4	1.5/8-12	1

WE - BT

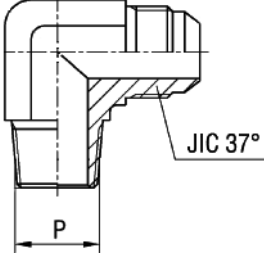
description	press. [bar]	code (carbon steel)	code (AISI 316)	pipe O.D.		JIC 37° [UN-UNF]	P [NPT]
				[mm]	[inch]		
90° elbow nipple, NPT (taper) thread 	350	HJ-WE-07-NT-02	HJ-WE-07-NT-02-SS	6	1/4	7/16-20	1/8
		HJ-WE-08-NT-02	HJ-WE-08-NT-02-SS	8	5/16	1/2-20	1/8
		HJ-WE-09-NT-04	HJ-WE-09-NT-04-SS	10	3/8	9/16-18	1/4
		HJ-WE-12-NT-06	HJ-WE-12-NT-06-SS	12	1/2	3/4-16	3/8
		HJ-WE-14-NT-08	HJ-WE-14-NT-08-SS	14-15-16	5/8	7/8-14	1/2
		HJ-WE-17-NT-12	HJ-WE-17-NT-12-SS	18-20	3/4	1.1/16-12	3/4
	290	HJ-WE-21-NT-16	HJ-WE-21-NT-16-SS	25	1	1.5/16-12	1
	240	HJ-WE-26-NT-20	HJ-WE-26-NT-20-SS	30-32	1.1/4	1.5/8-12	1.1/4
		HJ-WE-30-NT-24	HJ-WE-30-NT-24-SS	38	1.1/2	1.7/8-12	1.1/2
	350	HJ-WE-07-NT-04	HJ-WE-07-NT-04-SS	6	1/4	7/16-20	1/4
		HJ-WE-07-NT-06	HJ-WE-07-NT-06-SS	6	1/4	7/16-20	3/8
		HJ-WE-07-NT-08	-	6	1/4	7/16-20	1/2
		HJ-WE-08-NT-04	HJ-WE-08-NT-04-SS	8	5/16	1/2-20	1/4
		HJ-WE-09-NT-02	HJ-WE-09-NT-02-SS	10	3/8	9/16-18	1/8
		HJ-WE-09-NT-06	HJ-WE-09-NT-06-SS	10	3/8	9/16-18	3/8
		HJ-WE-09-NT-08	HJ-WE-09-NT-08-SS	10	3/8	9/16-18	1/2
		HJ-WE-12-NT-04	HJ-WE-12-NT-04-SS	12	1/2	3/4-16	1/4
		HJ-WE-12-NT-08	HJ-WE-12-NT-08-SS	12	1/2	3/4-16	1/2
		HJ-WE-12-NT-12	-	12	1/2	3/4-16	3/4
		HJ-WE-14-NT-06	HJ-WE-14-NT-06-SS	14-15-16	5/8	7/8-14	3/8
		HJ-WE-14-NT-12	HJ-WE-14-NT-12-SS	14-15-16	5/8	7/8-14	3/4
		HJ-WE-17-NT-08	HJ-WE-17-NT-08-SS	18-20	3/4	1.1/16-12	1/2
		290	HJ-WE-17-NT-16	HJ-WE-17-NT-16-SS	18-20	3/4	1.1/16-12
	HJ-WE-21-NT-12		HJ-WE-21-NT-12-SS	25	1	1.5/16-12	3/4
	240	HJ-WE-21-NT-20	-	25	1	1.5/16-12	1.1/4
		HJ-WE-26-NT-16	HJ-WE-26-NT-16-SS	30-32	1.1/4	1.5/8-12	1
		HJ-WE-26-NT-24	-	30-32	1.1/4	1.5/8-12	1.1/2
		HJ-WE-30-NT-20	HJ-WE-30-NT-20-SS	38	1.1/2	1.7/8-12	1.1/4

WE - NT

HIGH PRESSURE - JIC 37° connectors

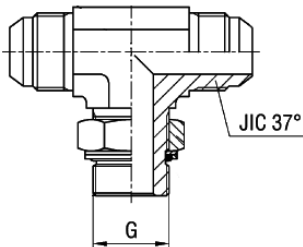
description	press. [bar]	code (carbon steel)	code (AISI 316)	pipe O.D.		JIC 37° [UN-UNF]	G [BSP]	
				[mm]	[inch]			
Adjustable tee nipple, BSP thread, ISO 6149-G seal 	350	HJ-TE-07-BG-02	-	6	1/4	7/16-20	1/8	
	315	HJ-TE-08-BG-04	-	8	5/16	1/2-20	1/4	
		HJ-TE-09-BG-04	-	10	3/8	9/16-18	1/4	
	250	HJ-TE-12-BG-06	-	12	1/2	3/4-16	3/8	
		HJ-TE-14-BG-08	-	14-15-16	5/8	7/8-14	1/2	
		HJ-TE-17-BG-12	-	18-20	3/4	1.1/16-12	3/4	
	200	HJ-TE-21-BG-16	-	25	1	1.5/16-12	1	
		HJ-TE-26-BG-20	-	30-32	1.1/4	1.5/8-12	1.1/4	
	160	HJ-TE-30-BG-24	-	38	1.1/2	17/8-12	1.1/2	
	315	HJ-TE-07-BG-04	-	6	1/4	7/16-20	1/4	
	250	HJ-TE-07-BG-06	-	6	1/4	7/16-20	3/8	
		HJ-TE-07-BG-08	-	6	1/4	7/16-20	1/2	
	350	HJ-TE-08-BG-02	-	8	5/16	1/2-20	1/8	
	250	HJ-TE-08-BG-06	-	8	5/16	1/2-20	3/8	
		HJ-TE-09-BG-06	-	10	3/8	9/16-18	3/8	
		HJ-TE-09-BG-08	-	10	3/8	9/16-18	1/2	
	315	HJ-TE-12-BG-04	-	12	1/2	3/4-16	1/4	
	250	HJ-TE-12-BG-08	-	12	1/2	3/4-16	1/2	
		HJ-TE-12-BG-12	-	12	1/2	3/4-16	3/4	
		HJ-TE-14-BG-06	-	14-15-16	5/8	7/8-14	3/8	
		HJ-TE-14-BG-12	-	14-15-16	5/8	7/8-14	3/4	
		HJ-TE-17-BG-08	-	18-20	3/4	1.1/16-12	1/2	
	200	HJ-TE-17-BG-16	-	18-20	3/4	1.1/16-12	1	
	250	HJ-TE-21-BG-12	-	25	1	1.5/16-12	3/4	
	200	HJ-TE-21-BG-20	-	25	1	1.5/16-12	1.1/4	
		HJ-TE-26-BG-16	-	30-32	1.1/4	1.5/8-12	1	
			HJ-TE-30-BG-20	-	38	1.1/2	1.7/8-12	1.1/4

TE - BG

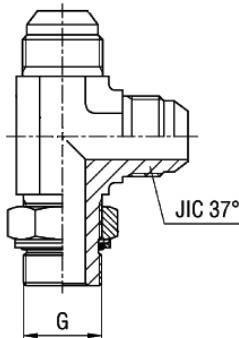
description	press. [bar]	code (carbon steel)	code (AISI 316)	pipe O.D.		JIC 37° [UN-UNF]	G [BSP]	
				[mm]	[inch]			
Adjustable tee nipple, BSP thread, ISO 6149-G seal 	350	HJ-LE-07-BG-02	-	6	1/4	7/16-20	1/8	
	315	HJ-LE-08-BG-04	-	8	5/16	1/2-20	1/4	
		HJ-LE-09-BG-04	-	10	3/8	9/16-18	1/4	
	250	HJ-LE-12-BG-06	-	12	1/2	3/4-16	3/8	
		HJ-LE-14-BG-08	-	14-15-16	5/8	7/8-14	1/2	
		HJ-LE-17-BG-12	-	18-20	3/4	1.1/16-12	3/4	
	200	HJ-LE-21-BG-16	-	25	1	1.5/16-12	1	
		HJ-LE-26-BG-20	-	30-32	1.1/4	1.5/8-12	1.1/4	
	160	HJ-LE-30-BG-24	-	38	1.1/2	1.7/8-12	1.1/2	
	315	HJ-LE-07-BG-04	-	6	1/4	7/16-20	1/4	
	250	HJ-LE-07-BG-06	-	6	1/4	7/16-20	3/8	
		HJ-LE-07-BG-08	-	6	1/4	7/16-20	1/2	
	350	HJ-LE-08-BG-02	-	8	5/16	1/2-20	1/8	
	250	HJ-LE-08-BG-06	-	8	5/16	1/2-20	3/8	
		HJ-LE-09-BG-06	-	10	3/8	9/16-18	3/8	
		HJ-LE-09-BG-08	-	10	3/8	9/16-18	1/2	
	315	HJ-LE-12-BG-04	-	12	1/2	3/4-16	1/4	
	250	HJ-LE-12-BG-08	-	12	1/2	3/4-16	1/2	
		HJ-LE-12-BG-12	-	12	1/2	3/4-16	3/4	
		HJ-LE-14-BG-06	-	14-15-16	5/8	7/8-14	3/8	
		HJ-LE-14-BG-12	-	14-15-16	5/8	7/8-14	3/4	
		HJ-LE-17-BG-08	-	18-20	3/4	1.1/16-12	1/2	
	200	HJ-LE-17-BG-16	-	18-20	3/4	1.1/16-12	1	
	250	HJ-LE-21-BG-12	-	25	1	1.5/16-12	3/4	
	200	HJ-LE-21-BG-20	-	25	1	1.5/16-12	1.1/4	
		HJ-LE-26-BG-16	-	30-32	1.1/4	1.5/8-12	1	
			HJ-LE-30-BG-20	-	38	1.1/2	1.7/8-12	1.1/4

LE - BG

HIGH PRESSURE - JIC 37° connectors

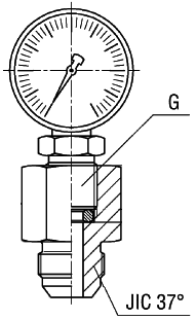
description	press. [bar]	code (carbon steel)	code (AISI 316)	pipe O.D.		JIC 37° [UN-UNF]	G [BSP]
				[mm]	[inch]		
Gauge fitting  MAV	350	HJ-MAV-07-04	HJ-MAV-07-04-SS	6	1/4	7/16-20	1/4
		HJ-MAV-08-04	HJ-MAV-08-04-SS	8	5/16	1/2-20	1/4
		HJ-MAV-09-04	HJ-MAV-09-04-SS	10	3/8	9/16-18	1/4
		HJ-MAV-12-04	HJ-MAV-12-04-SS	12	1/2	3/4-16	1/4
		HJ-MAV-07-08	HJ-MAV-07-08-SS	6	1/4	7/16-20	1/2
		HJ-MAV-08-08	HJ-MAV-08-08-SS	8	5/16	1/2-20	1/2
		HJ-MAV-09-08	HJ-MAV-09-08-SS	10	3/8	9/16-18	1/2
		HJ-MAV-12-08	HJ-MAV-12-08-SS	12	1/2	3/4-16	1/2

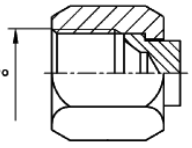
description	press. [bar]	code (carbon steel)	code (AISI 316)	pipe O.D.		JIC 37° [UN-UNF]
				[mm]	[inch]	
Plug, female thread  VKA	450	HJ-VKA-07	HJ-VKA-07-SS	6	1/4	7/16-20
		HJ-VKA-08	HJ-VKA-08-SS	8	5/16	1/2-20
	350	HJ-VKA-09	HJ-VKA-09-SS	10	3/8	9/16-18
		HJ-VKA-12	HJ-VKA-12-SS	12	1/2	3/4-16
		HJ-VKA-14	HJ-VKA-14-SS	14-15-16	5/8	7/8-14
		HJ-VKA-17	HJ-VKA-17-SS	18-20	3/4	1.1/16-12
	290	HJ-VKA-21	HJ-VKA-21-SS	25	1	1.5/16-12
	240	HJ-VKA-26	HJ-VKA-26-SS	30-32	1.1/4	1.5/8-12
		HJ-VKA-30	HJ-VKA-30-SS	38	1.1/2	1.7/8-12

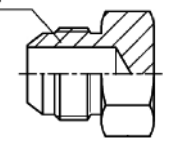
description	press. [bar]	code (carbon steel)	code (AISI 316)	pipe O.D.		JIC 37° [UN-UNF]
				[mm]	[inch]	
Plug, male thread  ROV	450	HJ-ROV-07	HJ-ROV-07-SS	6	1/4	7/16-20
		HJ-ROV-08	HJ-ROV-08-SS	8	5/16	1/2-20
	350	HJ-ROV-09	HJ-ROV-09-SS	10	3/8	9/16-18
		HJ-ROV-12	HJ-ROV-12-SS	12	1/2	3/4-16
		HJ-ROV-14	HJ-ROV-14-SS	14-15-16	5/8	7/8-14
		HJ-ROV-17	HJ-ROV-17-SS	18-20	3/4	1.1/16-12
	290	HJ-ROV-21	HJ-ROV-21-SS	25	1	1.5/16-12
	240	HJ-ROV-26	HJ-ROV-26-SS	30-32	1.1/4	1.5/8-12
		HJ-ROV-30	HJ-ROV-30-SS	38	1.1/2	1.7/8-12

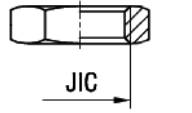
description	press. [bar]	code (carbon steel)	code (AISI 316)	pipe O.D.		JIC 37° [UN-UNF]
				[mm]	[inch]	
Flat nut for bulkhead connectors  MP	450	HJ-MP-07	-	6	1/4	7/16-20
		HJ-MP-08	-	8	5/16	1/2-20
	350	HJ-MP-09	-	10	3/8	9/16-18
		HJ-MP-12	-	12	1/2	3/4-16
		HJ-MP-14	-	14-15-16	5/8	7/8-14
	290	HJ-MP-17	-	18-20	3/4	1.1/16-12
		HJ-MP-21	-	25	1	1.5/16-12
	240	HJ-MP-26	-	30-32	1.1/4	1.5/8-12
		HJ-MP-30	-	38	1.1/2	1.7/8-12

HIGH PRESSURE - ORFS connectors

SAE fittings - J1453 (ORFS)

ORFS (O-Ring Face Seal) connectors are used to connect rigid pipes in hydraulic applications. Pipe ends are flared at 90 C angle. The sealing is achieved by pressing an O-ring placed in the groove of the surface front flat-face of the fitting with a male thread. The ORFS fittings can also be connected with fittings of flexible hydraulic hose assemblies (e.g. TI-ZOW110, ZOZ110).

Material: zinc-plated carbon steel or AISI 316 steel. Add SS to the code of AISI 316 connector.

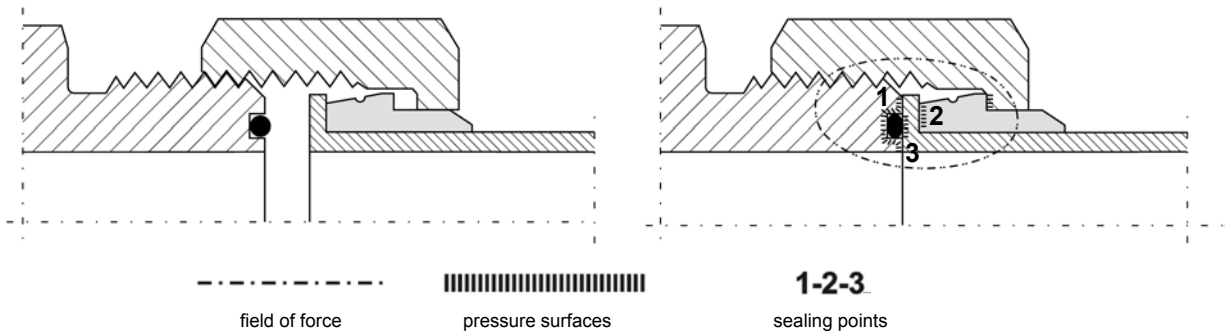

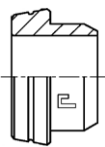
description	pressure [bar]	code (carbon steel)	pipe O.D.	
			[mm]	[inch]
 FM FC	630	HO-FC-04	-	1/4
		HO-FC-05	-	5/16
		HO-FC-06	-	3/8
		HO-FC-08	-	1/2
	420	HO-FC-10	-	5/8
		HO-FC-12	-	3/4
		HO-FC-14	-	7/8
		HO-FC-16	-	1
	280	HO-FC-20	-	1.1/4
		HO-FC-24	-	1.1/2
	630	HO-FM-06	6	-
		HO-FM-08	8	-
		HO-FM-10	10	-
		HO-FM-12	12	-
	420	HO-FM-14	14	-
		HO-FM-15	15	-
		HO-FM-16	16	-
		HO-FM-18	18	-
		HO-FM-20	20	-
		HO-FM-22	22	-
280	HO-FM-25	25	-	
	HO-FM-28	28	-	
	HO-FM-30	30	-	
	HO-FM-32	32	-	
	HO-FM-35	35	-	
	HO-FM-38	38	-	

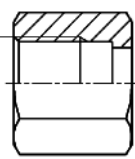
description	pressure [bar]	code (carbon steel)	pipe O.D.		ORFS
			[mm]	[inch]	
 M	630	HO-M-09	6	1/4	9/16-18
		HO-M-11	8-10	5/16-3/8	11/16-16
		HO-M-13	12	1/2	13/16-16
	420	HO-M-16	14-15-16	5/8	1-14
		HO-M-19	18-20	3/4	1.3/16-12
		HO-M-23	22-25	7/8-1	1.7/16-12
	280	HO-M-27	28-30-32	1.1/4	1.11/16-12
		HO-M-32	35-38	1.1/2	2-12

HIGH PRESSURE - ORFS connectors

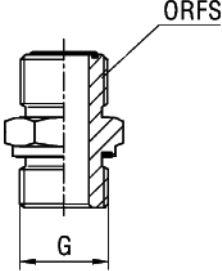
description	pressure [bar]	code (carbon steel)	approx. pipe O.D.		ORFS	G [BSP]
			[mm]	[inch]		
Straight nipple, BSP thread (elastomeric seal)  GE - BE	630	HO-GE-09-BE-02	6	1/4	9/16-18	1/8
		HO-GE-09-BE-04	6	1/4	9/16-18	1/4
		HO-GE-09-BE-06	6	1/4	9/16-18	3/8
		HO-GE-09-BE-08	6	1/4	9/16-18	1/2
		HO-GE-11-BE-02	8-10	5/16-3/8	11/16-16	1/8
		HO-GE-11-BE-04	8-10	5/16-3/8	11/16-16	1/4
		HO-GE-11-BE-06	8-10	5/16-3/8	11/16-16	3/8
	HO-GE-11-BE-08	8-10	5/16-3/8	11/16-16	1/2	
	420	HO-GE-11-BE-12	8-10	5/16-3/8	11/16-16	3/4
	630	HO-GE-13-BE-04	12	1/2	13/16-16	1/4
		HO-GE-13-BE-06	12	1/2	13/16-16	3/8
		HO-GE-13-BE-08	12	1/2	13/16-16	1/2
	420	HO-GE-13-BE-12	12	1/2	13/16-16	3/4
		HO-GE-16-BE-04	14-15-16	5/8	1-14	1/4
		HO-GE-16-BE-06	14-15-16	5/8	1-14	3/8
		HO-GE-16-BE-08	14-15-16	5/8	1-14	1/2
		HO-GE-16-BE-12	14-15-16	5/8	1-14	3/4
		HO-GE-16-BE-16	14-15-16	5/8	1-14	1
		HO-GE-19-BE-04	18-20	3/4	1.3/16-12	1/4
		HO-GE-19-BE-08	18-20	3/4	1.3/16-12	1/2
		HO-GE-19-BE-12	18-20	3/4	1.3/16-12	3/4
		HO-GE-19-BE-16	18-20	3/4	1.3/16-12	1
		HO-GE-19-BE-20	18-20	3/4	1.3/16-12	1.1/4
		HO-GE-23-BE-04	22-25	7/8-1	1.7/16-12	1/4
		HO-GE-23-BE-12	22-25	7/8-1	1.7/16-12	3/4
	HO-GE-23-BE-16	22-25	7/8-1	1.7/16-12	1	
	280	HO-GE-23-BE-20	22-25	7/8-1	1.7/16-12	1.1/4
		HO-GE-23-BE-24	22-25	7/8-1	1.7/16-12	1.1/2
		HO-GE-27-BE-16	28-30-32	1.1/4	1.11/16-12	1
		HO-GE-27-BE-20	28-30-32	1.1/4	1.11/16-12	1.1/4
HO-GE-27-BE-24		28-30-32	1.1/4	1.11/16-12	1.1/2	
HO-GE-32-BE-24	35-38	1.1/2	2-12	1.1/2		

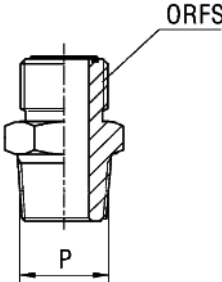
description	pressure [bar]	code (carbon steel)	approx. pipe O.D.		ORFS	P [NPTF]
			[mm]	[inch]		
Straight nipple, NPTF thread  GE - NT	420	HO-GE-09-NT-02	6	1/4	9/16-18	1/8
	630	HO-GE-09-NT-04	6	1/4	9/16-18	1/4
		HO-GE-09-NT-06	6	1/4	9/16-18	3/8
		HO-GE-11-NT-04	8-10	5/16-3/8	11/16-16	1/4
		HO-GE-11-NT-06	8-10	5/16-3/8	11/16-16	3/8
		HO-GE-11-NT-08	8-10	5/16-3/8	11/16-16	1/2
		HO-GE-13-NT-04	12	1/2	13/16-16	1/4
		HO-GE-13-NT-06	12	1/2	13/16-16	3/8
	420	HO-GE-13-NT-08	12	1/2	13/16-16	1/2
		HO-GE-13-NT-12	12	1/2	13/16-16	3/4
		HO-GE-16-NT-06	14-15-16	5/8	1-14	3/8
		HO-GE-16-NT-08	14-15-16	5/8	1-14	1/2
		HO-GE-16-NT-12	14-15-16	5/8	1-14	3/4
		HO-GE-19-NT-08	18-20	3/4	1.3/16-12	1/2
		HO-GE-19-NT-12	18-20	3/4	1.3/16-12	3/4
		HO-GE-19-NT-16	18-20	3/4	1.3/16-12	1
		HO-GE-23-NT-12	22-25	7/8-1	1.7/16-12	3/4
		HO-GE-23-NT-16	22-25	7/8-1	1.7/16-12	1
	280	HO-GE-27-NT-16	28-30-32	1.1/4	1.11/16-12	1
		HO-GE-27-NT-20	28-30-32	1.1/4	1.11/16-12	1.1/4
		HO-GE-32-NT-20	35-38	1.1/2	2-12	1.1/4
		HO-GE-32-NT-24	35-38	1.1/2	2-12	1.1/2

HIGH PRESSURE - ORFS connectors

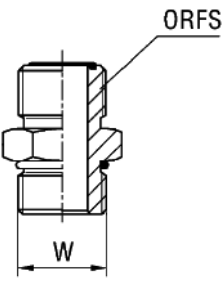
description	pressure [bar]	code (carbon steel)	approx. pipe O.D.		ORFS	W [UNF]	
			[mm]	[inch]			
Straight nipple, UNF thread (O-ring + washer seal)  GE - UN	630	HO-GE-09-UN-07	6	1/4	9/16-18	7/16-20	
		HO-GE-09-UN-08	6	1/4	9/16-18	1/2-20	
		HO-GE-09-UN-09	6	1/4	9/16-18	9/16-18	
		HO-GE-09-UN-12	6	1/4	9/16-18	3/4-16	
		HO-GE-11-UN-07	8-10	5/16-3/8	11/16-16	7/16-20	
		HO-GE-11-UN-08	8-10	5/16-3/8	11/16-16	1/2-20	
		HO-GE-11-UN-09	8-10	5/16-3/8	11/16-16	9/16-18	
		HO-GE-11-UN-12	8-10	5/16-3/8	11/16-16	3/4-16	
	HO-GE-11-UN-14	8-10	5/16-3/8	11/16-16	7/8-14		
	420	HO-GE-11-UN-17	8-10	5/16-3/8	11/16-16	1.1/16-12	
	630	HO-GE-13-UN-09	12	1/2	13/16-16	9/16-18	
		HO-GE-13-UN-12	12	1/2	13/16-16	3/4-16	
		HO-GE-13-UN-14	12	1/2	13/16-16	7/8-14	
		HO-GE-13-UN-17	12	1/2	13/16-16	1.1/16-12	
	420	HO-GE-13-UN-21	12	1/2	13/16-16	1.5/16-12	
		HO-GE-16-UN-12	14-15-16	5/8	1-14	3/4-16	
		HO-GE-16-UN-14	14-15-16	5/8	1-14	7/8-14	
		HO-GE-16-UN-17	14-15-16	5/8	1-14	1.1/16-12	
		HO-GE-19-UN-12	18-20	3/4	1.3/16-12	3/4-16	
		HO-GE-19-UN-14	18-20	3/4	1.3/16-12	7/8-14	
		HO-GE-19-UN-17	18-20	3/4	1.3/16-12	1.1/16-12	
		HO-GE-19-UN-21	18-20	3/4	1.3/16-12	1.5/16-12	
		HO-GE-23-UN-17	22-25	7/8-1	1.7/16-12	1.1/16-12	
		HO-GE-23-UN-21	22-25	7/8-1	1.7/16-12	1.5/16-12	
		280	HO-GE-23-UN-26	22-25	7/8-1	1.7/16-12	1.5/8-12
			HO-GE-27-UN-21	28-30-32	1.1/4	1.11/16-12	1.5/16-12
	HO-GE-27-UN-26		28-30-32	1.1/4	1.11/16-12	1.5/8-12	
	HO-GE-27-UN-30		28-30-32	1.1/4	1.11/16-12	1.7/8-12	
	HO-GE-32-UN-26		35-38	1.1/2	2-12	1.5/8-12	
	HO-GE-32-UN-30		35-38	1.1/2	2-12	1.7/8-12	

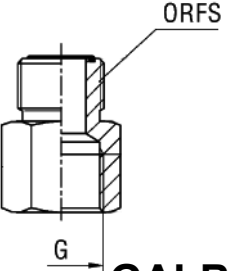
description	pressure [bar]	code (carbon steel)	approx. pipe O.D.		ORFS	G [BSP]
			[mm]	[inch]		
Straight fitting, BSP thread  GAI-B	630	HO-GAI-09-B-04	6	1/4	9/16-18	1/4
		HO-GAI-11-B-04	8-10	5/16-3/8	11/16-16	1/4
		HO-GAI-13-B-04	12	1/2	13/16-16	1/4
		HO-GAI-13-B-06	12	1/2	13/16-16	3/8
	420	HO-GAI-16-B-08	14-15-16	5/8	1-14	1/2
		HO-GAI-19-B-08	18-20	3/4	1.3/16-12	1/2
		HO-GAI-19-B-12	18-20	3/4	1.3/16-12	3/4
		HO-GAI-23-B-16	22-25	7/8-1	1.7/16-12	1
	280	HO-GAI-27-B-20	28-30-32	1.1/4	1.11/16-12	1.1/4
		HO-GAI-32-B-24	35-38	1.1/2	2-12	1.1/2

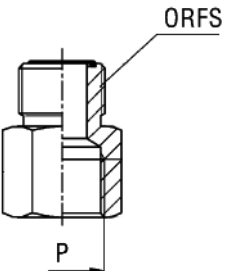
description	pressure [bar]	code (carbon steel)	approx. pipe O.D.		ORFS	P [NPTF]
			[mm]	[inch]		
Straight fitting, NPTF thread  GAI-N	630	HO-GAI-09-N-04	6	1/4	9/16-18	1/4
		HO-GAI-11-N-04	8-10	5/16-3/8	11/16-16	1/4
		HO-GAI-13-N-04	12	1/2	13/16-16	1/4
		HO-GAI-13-N-06	12	1/2	13/16-16	3/8
	420	HO-GAI-16-N-08	14-15-16	5/8	1-14	1/2
		HO-GAI-19-N-08	18-20	3/4	1.3/16-12	1/2
		HO-GAI-19-N-12	18-20	3/4	1.3/16-12	3/4
		HO-GAI-23-N-16	22-25	7/8-1	1.7/16-12	1
	280	HO-GAI-27-N-20	28-30-32	1.1/4	1.11/16-12	1.1/4
		HO-GAI-32-N-24	35-38	1.1/2	2-12	1.1/2

HIGH PRESSURE - ORFS connectors

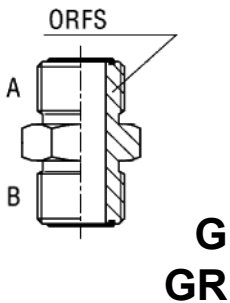
description	pressure [bar]	code (carbon steel)	approx. pipe O.D.				ORFS A	ORFS B
			A [mm]	A [inch]	B [mm]	B [inch]		
Straight connector, ORFS male thread 	630	HO-G-09	6	1/4	6	1/4	9/16-18	9/16-18
		HO-G-11	8-10	5/16-3/8	8-10	5/16-3/8	11/16-16	11/16-16
		HO-G-13	12	1/2	12	1/2	13/16-16	13/16-16
	420	HO-G-16	14-15-16	5/8	14-15-16	5/8	1-14	1-14
		HO-G-19	18-20	3/4	18-20	3/4	1.3/16-12	1.3/16-12
		HO-G-23	22-25	7/8-1	22-25	7/8-1	1.7/16-12	1.7/16-12
	280	HO-G-27	28-30-32	1.1/4	28-30-32	1.1/4	1.11/16-12	1.11/16-12
		HO-G-32	35-38	1.1/2	35-38	1.1/2	2-12	2-12
	630	HO-GR-11-09	8-10	5/16-3/8	6	1/4	11/16-16	9/16-18
		HO-GR-13-11	12	1/2	8-10	3/8-5/16	13/16-16	11/16-16
	420	HO-GR-16-13	14-15-16	5/8	12	1/2	1-14	13/16-16
		HO-GR-19-11	18-20	3/4	8-10	3/8	1.3/16-12	11/16-16
		HO-GR-19-13	18-20	3/4	12	1/2	1.3/16-12	13/16-16
		HO-GR-19-16	18-20	3/4	14-15-16	5/8	1.3/16-12	1-14
	280	HO-GR-23-19	22-25	7/8-1	18-20	3/4	1.7/16-12	1.3/16-12
	280	HO-GR-27-23	28-30-32	1.1/4	22-25	7/8-1	1.11/16-12	1.7/16-12

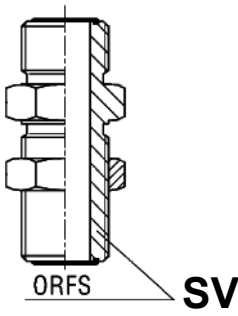
description	pressure [bar]	code (carbon steel)	approx. pipe O.D.		ORFS
			[mm]	[inch]	
Straight bulkhead connector, ORFS male thread 	630	HO-SV-09	6	1/4	9/16-18
		HO-SV-11	8-10	5/16-3/8	11/16-16
		HO-SV-13	12	1/2	13/16-16
	420	HO-SV-16	14-15-16	5/8	1-14
		HO-SV-19	18-20	3/4	1.3/16-12
	280	HO-SV-23	22-25	7/8-1	1.7/16-12
		HO-SV-27	28-30-32	1.1/4	1.11/16-12
		HO-SV-32	35-38	1.1/2	2-12

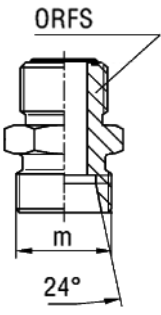
description	pressure [bar]	code (carbon steel)	approx. pipe O.D.		series	ORFS	M [metric]
			[mm]	[inch]			
Adapter ORFS male thread / DIN 2353 	315	HO-GE-09-M-06L	6	1/4	6L	9/16-18	12x1.5
	630	HO-GE-09-M-06S	6	1/4	6S	9/16-18	14x1.5
	315	HO-GE-09-M-08L	6	1/4	8L	9/16-18	14x1.5
	630	HO-GE-09-M-08S	6	1/4	8S	9/16-18	16x1.5
	315	HO-GE-11-M-10L	8-10	5/16-3/8	10L	11/16-16	16x1.5
	630	HO-GE-11-M-10S	8-10	5/16-3/8	10S	11/16-16	18x1.5
	315	HO-GE-13-M-12L	12	1/2	12L	13/16-16	18x1.5
	630	HO-GE-13-M-12S	12	1/2	12S	13/16-16	20x1.5
	420	HO-GE-16-M-14S	14-15-16	5/8	14S	1-14	22x1.5
	315	HO-GE-16-M-15L	14-15-16	5/8	15L	1-14	22x1.5
	400	HO-GE-16-M-16S	14-15-16	5/8	16S	1-14	24x1.5
	315	HO-GE-19-M-18L	18-20	3/4	18L	1.3/16-12	26x1.5
	400	HO-GE-19-M-20S	18-20	3/4	20S	1.3/16-12	30x2
	160	HO-GE-23-M-22L	22-25	1	22L	1.7/16-12	30x2
	400	HO-GE-23-M-25S	22-25	7/8-1	25S	1.7/16-12	36x2
	160	HO-GE-27-M-28L	28-30-32	1.1/4	28L	1.11/16-12	36x2
	280	HO-GE-27-M-30S	28-30-32	1.1/4	30S	1.11/16-12	42x2
	160	HO-GE-32-M-35L	35-38	1.1/2	35L	2-12	45x2
	280	HO-GE-32-M-38S	35-38	1.1/2	38S	2-12	52x2
	160	HO-GE-32-M-42L	35-38	1.1/2	42L	2-12	52x2

HIGH PRESSURE - ORFS connectors

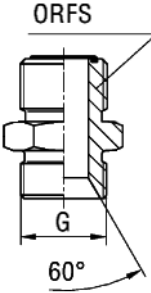
description	pressure [bar]	code (carbon steel)	approx. pipe O.D.		ORFS	G [BSP]
			[mm]	[inch]		
Adapter ORFS male / BSP 60° male thread  GE - B	400	HO-GE-09-B-02	6	1/4	9/16-18	1/8
		HO-GE-09-B-04	6	1/4	9/16-18	1/4
		HO-GE-09-B-06	6	1/4	9/16-18	3/8
		HO-GE-11-B-04	8-10	5/16-3/8	11/16-16	1/4
		HO-GE-11-B-06	8-10	5/16-3/8	11/16-16	3/8
	350	HO-GE-11-B-08	8-10	5/16-3/8	11/16-16	1/2
	400	HO-GE-13-B-04	12	1/2	13/16-16	1/4
		HO-GE-13-B-06	12	1/2	13/16-16	3/8
	350	HO-GE-13-B-08	12	1/2	13/16-16	1/2
	315	HO-GE-13-B-12	12	1/2	13/16-16	3/4
	400	HO-GE-16-B-06	14-15-16	5/8	1-14	3/8
	350	HO-GE-16-B-08	14-15-16	5/8	1-14	1/2
		HO-GE-16-B-10	14-15-16	5/8	1-14	5/8
	315	HO-GE-16-B-12	14-15-16	5/8	1-14	3/4
	350	HO-GE-19-B-08	18-20	3/4	1.3/16-12	1/2
	315	HO-GE-19-B-12	18-20	3/4	1.3/16-12	3/4
	250	HO-GE-19-B-16	18-20	3/4	1.3/16-12	1
	315	HO-GE-23-B-12	22-25	7/8-1	1.7/16-12	3/4
	250	HO-GE-23-B-16	22-25	7/8-1	1.7/16-12	1
	200	HO-GE-23-B-20	22-25	7/8-1	1.7/16-12	1.1/4
HO-GE-27-B-20		28-30-32	1.1/4	1.11/16-12	1.1/4	
160	HO-GE-32-B-24	35-38	1.1/2	2-12	1.1/2	

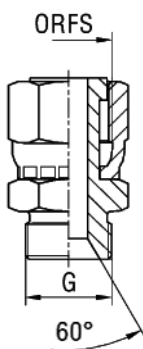
description	pressure [bar]	code (carbon steel)	approx. pipe O.D.		ORFS	G [BSP]
			[mm]	[inch]		
Adapter ORFS female / BSP 60° male thread  EVGE - B	400	HO-EVGE-09-B-02	6	1/4	9/16-18	1/8
		HO-EVGE-09-B-04	6	1/4	9/16-18	1/4
		HO-EVGE-09-B-06	6	1/4	9/16-18	3/8
		HO-EVGE-11-B-04	8-10	5/16-3/8	11/16-16	1/4
		HO-EVGE-11-B-06	8-10	5/16-3/8	11/16-16	3/8
	350	HO-EVGE-11-B-08	8-10	5/16-3/8	11/16-16	1/2
	400	HO-EVGE-13-B-04	12	1/2	13/16-16	1/4
		HO-EVGE-13-B-06	12	1/2	13/16-16	3/8
	350	HO-EVGE-13-B-08	12	1/2	13/16-16	1/2
	315	HO-EVGE-13-B-12	12	1/2	13/16-16	3/4
	400	HO-EVGE-16-B-06	14-15-16	5/8	1-14	3/8
	350	HO-EVGE-16-B-08	14-15-16	5/8	1-14	1/2
		HO-EVGE-16-B-10	14-15-16	5/8	1-14	5/8
	315	HO-EVGE-16-B-12	14-15-16	5/8	1-14	3/4
	350	HO-EVGE-19-B-08	18-20	3/4	1.3/16-12	1/2
	315	HO-EVGE-19-B-12	18-20	3/4	1.3/16-12	3/4
	250	HO-EVGE-19-B-16	18-20	3/4	1.3/16-12	1
	315	HO-EVGE-23-B-12	22-25	7/8-1	1.7/16-12	3/4
	250	HO-EVGE-23-B-16	22-25	7/8-1	1.7/16-12	1
	200	HO-EVGE-23-B-20	22-25	7/8-1	1.7/16-12	1.1/4
HO-EVGE-27-B-20		28-30-32	1.1/4	1.11/16-12	1.1/4	
160	HO-EVGE-32-B-24	35-38	1.1/2	2-12	1.1/2	

HIGH PRESSURE - ORFS connectors

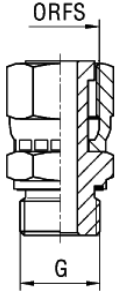
description	pressure [bar]	code (carbon steel)	approx. pipe O.D.		ORFS	G [BSP]
			[mm]	[inch]		
Straight fitting, BSP male thread (elastomeric seal) 	630	HO-EVGE-09-BE-02	6	1/4	9/16-18	1/8
		HO-EVGE-09-BE-04	6	1/4	9/16-18	1/4
		HO-EVGE-11-BE-04	8-10	5/16-3/8	11/16-16	1/4
		HO-EVGE-11-BE-06	8-10	5/16-3/8	11/16-16	3/8
		HO-EVGE-13-BE-06	12	1/2	13/16-16	3/8
		HO-EVGE-13-BE-08	12	1/2	13/16-16	1/2
	420	HO-EVGE-16-BE-08	14-15-16	5/8	1-14	1/2
		HO-EVGE-19-BE-12	18-20	3/4	1.3/16-12	3/4
		HO-EVGE-19-BE-20	18-20	3/4	1.3/16-12	1.1/4
		HO-EVGE-23-BE-16	22-25	7/8-1	1.7/16-12	1
	280	HO-EVGE-27-BE-20	28-30-32	1.1/4	1.11/16-12	1.1/4
		HO-EVGE-32-BE-24	35-38	1.1/2	2-12	1.1/2

EVGE - BE

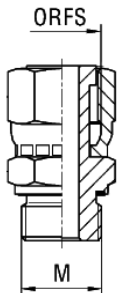
description	pressure [bar]	code (carbon steel)	approx. pipe O.D.		ORFS	M [metric]
			[mm]	[inch]		
Straight fitting, metric male thread (elastomeric seal) 	350	HO-EVGE-09-ME-10	6	1/4	9/16-18	10x1
	630	HO-EVGE-09-ME-12	6	1/4	9/16-18	12x1.5
		HO-EVGE-11-ME-14	8-10	5/16-3/8	11/16-16	14x1.5
		HO-EVGE-11-ME-16	8-10	5/16-3/8	11/16-16	16x1.5
		HO-EVGE-13-ME-16	12	1/2	13/16-16	16x1.5
		HO-EVGE-13-ME-18	12	1/2	13/16-16	18x1.5
	420	HO-EVGE-16-ME-18	14-15-16	5/8	1-14	18x1.5
		HO-EVGE-16-ME-22	14-15-16	5/8	1-14	22x1.5
		HO-EVGE-19-ME-22	18-20	3/4	1.3/16-12	22x1.5
		HO-EVGE-19-ME-27	18-20	3/4	1.3/16-12	27x2
		HO-EVGE-23-ME-27	22-25	7/8-1	1.7/16-12	27x2
		HO-EVGE-23-ME-33	22-25	7/8-1	1.7/16-12	33x2
	280	HO-EVGE-27-ME-42	28-30-32	1 1/4	1.11/16-12	42x2
		HO-EVGE-32-ME-48	35-38	1 1/2	2-12	48x2

EVGE - ME

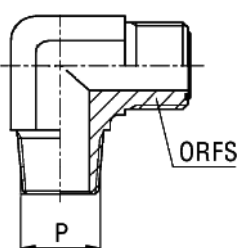
description	pressure [bar]	code (carbon steel)	approx. pipe O.D.		ORFS	P [NPTF]
			[mm]	[inch]		
90° elbow nipple, NPTF thread 	420	HO-WE-09-NT-02	6	1/4	9/16-18	1/8
	630	HO-WE-09-NT-04	6	1/4	9/16-18	1/4
		HO-WE-09-NT-06	6	1/4	9/16-18	3/8
		HO-WE-11-NT-04	8-10	5/16-3/8	11/16-16	1/4
		HO-WE-11-NT-06	8-10	5/16-3/8	11/16-16	3/8
		HO-WE-11-NT-08	8-10	5/16-3/8	11/16-16	1/2
		HO-WE-13-NT-04	12	1/2	13/16-16	1/4
		HO-WE-13-NT-06	12	1/2	13/16-16	3/8
		HO-WE-13-NT-08	12	1/2	13/16-16	1/2
	420	HO-WE-13-NT-12	12	1/2	13/16-16	3/4
		HO-WE-16-NT-06	14-15-16	5/8	1-14	3/8
		HO-WE-16-NT-08	14-15-16	5/8	1-14	1/2
		HO-WE-16-NT-12	14-15-16	5/8	1-14	3/4
		HO-WE-19-NT-08	18-20	3/4	1.3/16-12	1/2
		HO-WE-19-NT-12	18-20	3/4	1.3/16-12	3/4
		HO-WE-19-NT-16	18-20	3/4	1.3/16-12	1
		HO-WE-23-NT-12	22-25	7/8-1	1.7/16-12	3/4
	280	HO-WE-23-NT-16	22-25	7/8-1	1.7/16-12	1
		HO-WE-27-NT-16	28-30-32	1.1/4	1.11/16-12	1
		HO-WE-27-NT-20	28-30-32	1.1/4	1.11/16-12	1.1/4
HO-WE-32-NT-20		35-38	1.1/2	2-12	1.1/4	
		HO-WE-32-NT-24	35-38	1.1/2	2-12	1.1/2

WE - NT

HIGH PRESSURE - ORFS connectors

description	pressure [bar]	code (carbon steel)	approx. pipe O.D.		ORFS	G [BSP]
			[mm]	[inch]		
Adjustable 90° elbow nipple, BSP thread (O-ring + washer seal)	350	HO-WE-09-BG-02	6	1/4	9/16-18	1/8
	315	HO-WE-09-BG-04	6	1/4	9/16-18	1/4
	250	HO-WE-09-BG-06	6	1/4	9/16-18	3/8
	315	HO-WE-11-BG-04	8-10	5/16-3/8	11/16-16	1/4
		HO-WE-11-BG-06	8-10	5/16-3/8	11/16-16	3/8
		HO-WE-11-BG-08	8-10	5/16-3/8	11/16-16	1/2
	250	HO-WE-13-BG-04	12	1/2	13/16-16	1/4
		HO-WE-13-BG-06	12	1/2	13/16-16	3/8
		HO-WE-13-BG-08	12	1/2	13/16-16	1/2
	315	HO-WE-16-BG-04	14-15-16	5/8	1-14	1/4
		HO-WE-16-BG-06	14-15-16	5/8	1-14	3/8
		HO-WE-16-BG-08	14-15-16	5/8	1-14	1/2
	250	HO-WE-16-BG-12	14-15-16	5/8	1-14	3/4
		HO-WE-16-BG-16	14-15-16	5/8	1-14	1
		HO-WE-16-BG-20	14-15-16	5/8	1-14	1.1/4
	200	HO-WE-16-BG-16	14-15-16	5/8	1-14	1
	315	HO-WE-19-BG-04	18-20	3/4	1.3/16-12	1/4
	250	HO-WE-19-BG-08	18-20	3/4	1.3/16-12	1/2
		HO-WE-19-BG-12	18-20	3/4	1.3/16-12	3/4
	200	HO-WE-19-BG-16	18-20	3/4	1.3/16-12	1
	315	HO-WE-23-BG-04	22-25	7/8-1	1.7/16-12	1/4
	250	HO-WE-23-BG-12	22-25	7/8-1	1.7/16-12	3/4
	200	HO-WE-23-BG-16	22-25	7/8-1	1.7/16-12	1
		HO-WE-23-BG-20	22-25	7/8-1	1.7/16-12	1.1/4
		HO-WE-27-BG-16	28-30-32	1.1/4	1.11/16-12	1
		HO-WE-27-BG-20	28-30-32	1.1/4	1.11/16-12	1.1/4
	160	HO-WE-27-BG-24	28-30-32	1.1/4	1.11/16-12	1.1/2
HO-WE-32-BG-24		35-38	1.1/2	2-12	1.1/2	

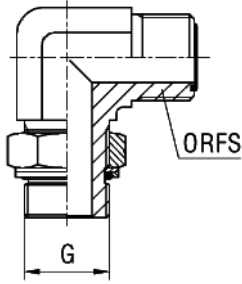

WE - BG

description	pressure [bar]	code (carbon steel)	approx. pipe O.D.		ORFS	M [metric]
			[mm]	[inch]		
Adjustable 90° elbow nipple, metric thread (O-ring + washer seal)	315	HO-WE-09-MG-10	6	1/4	9/16-18	10x1
		HO-WE-09-MG-12	6	1/4	9/16-18	M2x1.5
		HO-WE-11-MG-14	8-10	5/16-3/8	11/16-16	14x1.5
		HO-WE-11-MG-16	8-10	5/16-3/8	11/16-16	16x1.5
		HO-WE-13-MG-16	12	1/2	13/16-16	16x1.5
		HO-WE-13-MG-18	12	1/2	13/16-16	18x1.5
	250	HO-WE-13-MG-22	12	1/2	13/16-16	22x1.5
	315	HO-WE-16-MG-18	14-15-16	5/8	1-14	18x1.5
	250	HO-WE-16-MG-22	14-15-16	5/8	1-14	22x1.5
		HO-WE-16-MG-27	14-15-16	5/8	1-14	27x2
		HO-WE-19-MG-22	18-20	3/4	1.3/16-12	22x1.5
		HO-WE-19-MG-27	18-20	3/4	1.3/16-12	27x2
	160	HO-WE-19-MG-33	18-20	3/4	1.3/16-12	33x2
	160	HO-WE-23-MG-27	22-25	7/8-1	1.7/16-12	27x2
		HO-WE-23-MG-33	22-25	7/8-1	1.7/16-12	33x2
		HO-WE-23-MG-42	22-25	7/8-1	1.7/16-12	42x2
		HO-WE-27-MG-42	28-30-32	1.1/4	1.11/16-12	42x2
		HO-WE-27-MG-48	28-30-32	1.1/4	1.11/16-12	48x2
HO-WE-32-MG-48		35-38	1.1/2	2-12	48x2	

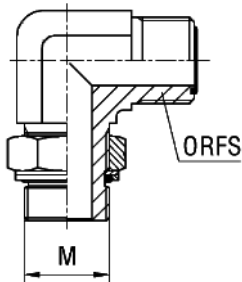

WE - MG

HIGH PRESSURE - ORFS connectors

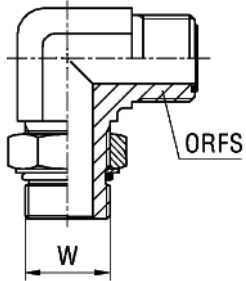
description	pressure [bar]	code (carbon steel)	approx. pipe O.D.		ORFS	W [UNF]
			[mm]	[inch]		
Adjustable 90° elbow nipple, UNF thread (O-ring seal) 	420	HO-WE-09-UG-07	6	1/4	9/16-18	7/16-20
		HO-WE-09-UG-09	6	1/4	9/16-18	9/16-18
		HO-WE-09-UG-12	6	1/4	9/16-18	3/4-16
		HO-WE-11-UG-07	8-10	5/16-3/8	11/16-16	7/16-20
		HO-WE-11-UG-09	8-10	5/16-3/8	11/16-16	9/16-18
		HO-WE-11-UG-12	8-10	5/16-3/8	11/16-16	3/4-16
		HO-WE-11-UG-14	8-10	5/16-3/8	11/16-16	7/8-14
		HO-WE-11-UG-17	8-10	5/16-3/8	11/16-16	1.1/16-12
		HO-WE-13-UG-09	12	1/2	13/16-16	9/16-18
		HO-WE-13-UG-12	12	1/2	13/16-16	3/4-16
		HO-WE-13-UG-14	12	1/2	13/16-16	7/8-14
		HO-WE-13-UG-17	12	1/2	13/16-16	1.1/16-12
		HO-WE-16-UG-12	14-15-16	5/8	1-14	3/4-16
		HO-WE-16-UG-14	14-15-16	5/8	1-14	7/8-14
		HO-WE-16-UG-17	14-15-16	5/8	1-14	1.1/16-12
		HO-WE-19-UG-12	18-20	3/4	1.3/16	3/4-16
	HO-WE-19-UG-14	18-20	3/4	1.3/16	7/8-14	
	HO-WE-19-UG-17	18-20	3/4	1.3/16-12	1.1/16-12	
	380	HO-WE-19-UG-21	18-20	3/4	1.3/16	1.5/16-12
	420	HO-WE-23-UG-17	22-25	7/8-1	1.7/16	1.1/16-12
	380	HO-WE-23-UG-21	22-25	7/8-1	1.7/16-11	1.5/16-12
	280	HO-WE-23-UG-26	22-25	7/8-1	1.7/16	1.5/8-12
		HO-WE-27-UG-21	28-30-32	1.1/4	1.11/16	1.5/16-12
		HO-WE-27-UG-26	28-30-32	1.1/4	1.11/16-12	1.5/8-12
		HO-WE-27-UG-30	28-30-32	1.1/4	1.11/16	1.7/8-12
		HO-WE-32-UG-26	35-38	1.1/2	2-12	1.5/8-12
HO-WE-32-UG-30	35-38	1.1/2	2-12	1.7/8-12		

WE - UG

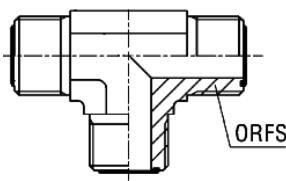
description	pressure [bar]	code (carbon steel)	approx. pipe O.D.		ORFS
			[mm]	[inch]	
Tee ORFS connector 	630	HO-T-09	6	1/4	9/16-18
		HO-T-11	8-10	5/16-3/8	11/16-16
		HO-T-13	12	1/2	13/16-16
	420	HO-T-16	14-15-16	5/8	1-14
		HO-T-19	18-20	3/4	1.3/16-12
		HO-T-23	22-25	7/8-1	1.7/16-12
	280	HO-T-27	28-30-32	1.1/4	1.11/16-12
		HO-T-32	35-38	1.1/2	2-12

T

HIGH PRESSURE - ORFS connectors

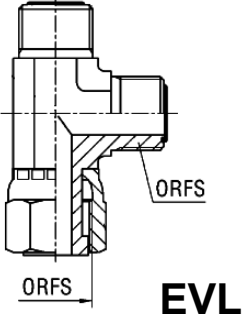
description	pressure [bar]	code (carbon steel)	approx. pipe O.D.		ORFS
			[mm]	[inch]	
Tee adapter L type ORFS male thread / female thread 	630	HO-EVL-09	6	1/4	9/16-18
		HO-EVL-11	8-10	5/16-3/8	11/16-16
		HO-EVL-13	12	1/2	13/16-16
	420	HO-EVL-16	14-15-16	5/8	1-14
		HO-EVL-19	18-20	3/4	1.3/16-12
		HO-EVL-23	22-25	7/8-1	1.7/16-12
	280	HO-EVL-27	28-30-32	1.1/4	1.11/16-12
		HO-EVL-32	35-38	1.1/2	2-12

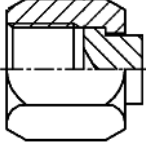
description	pressure [bar]	code (carbon steel)	approx. pipe O.D.		ORFS
			[mm]	[inch]	
Plug, ORFS, female thread 	630	HO-VKA-09	6	1/4	9/16-18
		HO-VKA-11	8-10	5/16-3/8	11/16-16
		HO-VKA-13	12	1/2	13/16-16
	420	HO-VKA-16	14-15-16	5/8	1-14
		HO-VKA-19	18-20	3/4	1.3/16-12
		HO-VKA-23	22-25	7/8-1	1.7/16-12
	280	HO-VKA-27	28-30-32	1.1/4	1.11/16-12
		HO-VKA-32	35-38	1.1/2	2-12

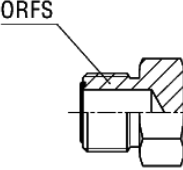
description	pressure [bar]	code (carbon steel)	approx. pipe O.D.		ORFS
			[mm]	[inch]	
Plug, ORFS, male thread 	630	HO-ROV-09	6	1/4	9/16-18
		HO-ROV-11	8-10	5/16-3/8	11/16-16
		HO-ROV-13	12	1/2	13/16-16
	420	HO-ROV-16	14-15-16	5/8	1-14
		HO-ROV-19	18-20	3/4	1.3/16-12
		HO-ROV-23	22-25	7/8-1	1.7/16-12
	280	HO-ROV-27	28-30-32	1.1/4	1.11/16-12
		HO-ROV-32	35-38	1.1/2	2-12

description	pressure [bar]	code (carbon steel)	approx. pipe O.D.		ORFS
			[mm]	[inch]	
Nut, UNF thread, for bulk-head connectors 	630	HO-MP-09	6	1/4	9/16-18
		HO-MP-11	8-10	5/16-3/8	11/16-16
		HO-MP-13	12	1/2	13/16-16
	420	HO-MP-16	14-15-16	5/8	1-14
		HO-MP-19	18-20	3/4	1.3/16-12
		HO-MP-23	22-25	7/8-1	1.7/16-12
	280	HO-MP-27	28-30-32	1.1/4	1.11/16-12
		HO-MP-32	35-38	1.1/2	2-12