

# MACHINES AND ACCESSORIES - hose reels

## General information

Hose reels are primarily intended to allow fast unwinding of the required length of a hose (flexible hose assembly), which is ready for operation and connected to a supply (of e.g. water, air) via the reel. When its operation is over, the hose is rewound on the hose reel.

### Advantages of using hose reels:

- enhanced work safety,
- minimized leakage,
- reduced hose wear,
- increased work efficiency,
- improved working environment.

### Types of hose reel drives:

- Spring driven hose reels: The hose is manually pulled to unwind to the required length and blocked by a ratchet mechanism. The more hose is pulled from the reel, the more the spring is stretched. When a pawl is released, the spring launches automatic rewinding of the hose onto a drum of the hose reel. Guiding the hose in hands secures the process. The spring driven hose reels are widely used, especially for lightweight and short hoses (several dozen of meters, depending on a diameter, limited by the tension and length to which the spring is stretched).



- Hand crank hose reels: A hose is reeled in and out manually by turning a crank attached to a hose reel drum (directly or through a gear). Used for longer hoses mainly (up to several hundreds of meters).



- Motor driver hose reels: A hose is reeled in and out by a motor which conveys power to a hose reel drum (through a gear or chain drive). Various types of drives are available - pneumatic, hydraulic and electric (12 V, 24 V, 110 V, 230 V, 400 V). The motor driven hose reels are recommended, when the hose is used very often or when the hose is particularly heavy and manual rewinding may not be possible.



## MACHINES AND ACCESSORIES - hose reels

### Hose reel construction - example

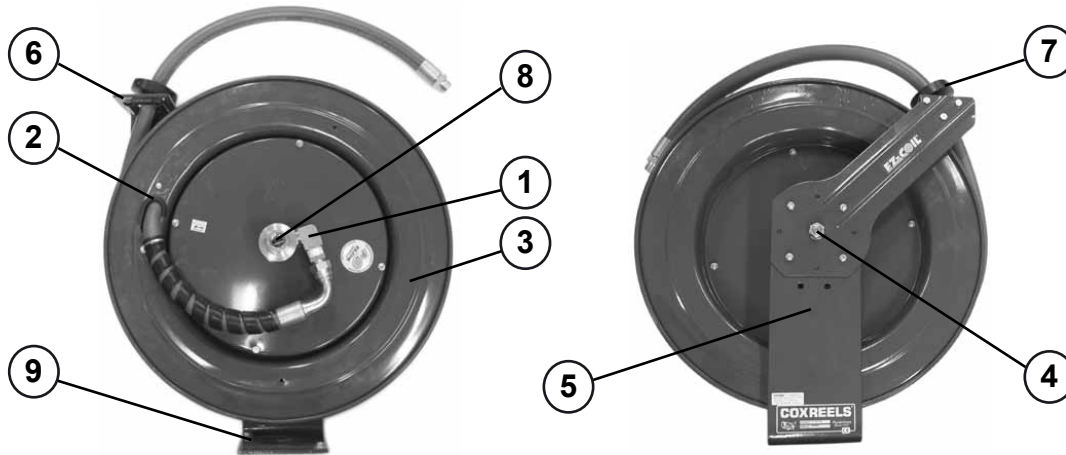

The main hose is connected to 90° swivel (1), led through a pass (2) and wound on a hose reel drum (3), mounted on an axle (4) fitted into a reel frame (5). The end of the main hose is led through a guiding arm (6) and secured with a bumper (7). A supply hose is connected to the inlet of a swivel (8). The base (9) allows wall-mounting. A spring mechanism is installed inside the drum, a ratchet mechanism that stops the hose at required length - on the axle of the hose reel.

### Hose reel selection

In order to match the hose reel model to the particular application properly, the following operation conditions and technical parameters must be considered:

a) Operation conditions:

- medium,
- working pressure,
- working and ambient temperature.

b) Technical parameters:

- internal and external diameter of the hose to be wound on the hose reel,
- type of the hose to be wound on the hose reel (due to their construction only some hoses are suitable for re-winding),
- hose bending radius (maximum a half of the hose reel drum diameter),
- length of the hose to be wound on the hose reel,
- drive of the hose reel,
- hose reel mounting position (wall, floor, ceiling, etc.).

### Note:

1. The maximum working pressure and temperature is always determined by the parameter of a smaller value in the hose reel - hose set.
2. The maximum hose length is limited by the drum capacity (diameter and width) for a hose of a particular external diameter, and, in the case of spring driven hose reels, maximum tension (number of revolutions) obtained by the spring.
3. A flexible hose assembly must be used to supply media to the inlet of a hose reel. Non-flexible connection may damage the hose reel.
4. When selecting a hose reel for chemically aggressive media, not only the hose must be resistant to them, but also the internal fluid path in the hose reel, the swivel connector and seal.

## MACHINES AND ACCESSORIES - hose reels

### REELCRAFT spring retractable reels



#### S series

**Material:** Polypropylene (black)  
**Working temp.:** Up to +65°C  
 (SHA3850 OLP version up to +85°C)

A general purpose hose reel, wall-mounted. Available with a hose and swivel mounting brackets as a standard. Widely used in car workshops, agriculture, gardening, industrial plants. A wire stand (RC-SG261398) to place the hose reel on the floor available on request.

Advantages: Light weight, corrosion resistant components.

code	usage	hose length [m]	hose I.D. [inch]	working pressure [bar]	weight [kg]	connection inlet / outlet [NPT fem. / NPT male]	
RC-SGA3665OLP	air / water	20	3/8	16	11.00	3/8	3/8
RC-SGA3850OLP	air / water	15	1/2	16	10.00	1/2	1/2
RC-SHA3850OLP	hot water	15	1/2	17	10.00	1/2	1/2



#### LC series

**Material:** Powder coated steel  
**Working temp.:** Up to +65°C

A hose reel intended for water and air; wall-mounted. A guide arm adjustable to five different positions allows to mount the reel in the most comfortable position. Widely used in car workshops, repair shops, petrol stations, gardening, paint shops, etc.

Advantages: easy installation, very long service life of a retraction spring.

code	usage	hose length [m]	hose I.D. [inch]	working pressure [bar]	weight [kg]	connection inlet / outlet [BSPT fem. / BSPT male]	
RC-LC650 OLP-70	with hose	15	3/8	21	17.00	1/4	1/4
RC-LC670 OLP-70	with hose	21	3/8	21	20.00	1/4	1/4
RC-LC850 OLP-70	with hose	15	1/2	21	19.00	1/2	1/2
RC-LC870 OLP-70	with hose	21	1/2	21	22.00	1/2	1/2
OLS version - stainless steel							
RC-LC607 OLS-70-S	without hose	21	3/8	21	16.00	1/4	1/4
RC-LC807 OLS-70-S	without hose	21	1/2	21	16.00	1/2	1/2

# MACHINES AND ACCESSORIES - hose reels

## REELCRAFT spring retractable reels



### REELTEK

**Material:** Powder coated steel, drum made of composite materials with fibre glass reinforcement.

**Working temp.:** Up to +65°C

A hose reel designed for such industrial applications as air, water, oil and lubricant transfer. Supplied with or without a hose. A guide arm adjustable to seven different positions allows to mount the reel in the most comfortable position.

Advantages: Light weight, highly reliable.

code	option	hose length [m]	hose I.D. [inch]	working pressure [bar]	weight [kg]	connection inlet / outlet [NPT female / NPT male]	
low pressure hose reels							
RC-RT435OLP	with hose	11	1/4	21	11.00	3/8	1/4
RC-RT403OLP	without hose	11	1/4	21	9.00	3/8	-
RC-RT450OLP	with hose	15	1/4	21	12.00	3/8	1/4
RC-RT405OLP	without hose	15	1/4	21	10.00	3/8	-
RC-RT650OLP	with hose	15	3/8	21	14.00	3/8	3/8
RC-RT605OLP	without hose	15	3/8	21	11.00	3/8	-
RC-RT835OLP	with hose	11	1/2	21	14.00	1/2	1/2
RC-RT803OLP	without hose	11	1/2	21	11.00	1/2	-
medium pressure hose reels							
RC-RT635OMP	with hose	11	1/4	69	14.00	3/8	3/8
RC-RT603OMP	without hose	11	1/4	69	10.00	3/8	-
RC-RT835OMP	with hose	11	3/8	69	16.00	1/2	1/2
RC-RT803OMP	without hose	11	3/8	69	11.00	1/2	-
high pressure hose reels							
RC-RT435OHP	with hose	11	1/4	345	15.00	3/8	1/4
RC-RT403OHP	without hose	11	1/4	345	10.00	3/8	-
RC-RT635OHP	with hose	11	3/8	276	16.00	1/2	3/8
RC-RT603OHP	without hose	11	3/8	276	11.00	1/2	-



### DP 7000

**Material:** Powder coated steel

**Working temp.:** Up to +100°C

A robust hose reel with a dual base of the drum to ensure stability and superior resistance to vibration. Complies to MIL-STD-810F standard (military truck-mounted equipment). A hose is not included, must be ordered separately.

Advantages: Suitable for heavy duty conditions.

code	option	hose length [m]	hose I.D. [inch]	working pressure [bar]	weight [kg]	connection inlet / outlet [NPT female / NPT male]	
low pressure hose reels							
RC-DP7600OLP	without hose	15	3/8	35	19.00	1/2	1/4
RC-DP7800OLP	without hose	15	1/2	35	20.00	1/2	3/8
medium pressure hose reels							
RC-DP7600OMP	without hose	15	3/8	207	21.00	1/2	3/8
RC-DP7800OMP	without hose	15	1/2	207	19.00	1/2	1/2

# MACHINES AND ACCESSORIES - hose reels

## REELCRAFT spring retractable reels



### FUEL 7000 / 80000 series

**Material:** Powder coated steel  
**Working temp.:** Up to +65°C

Due to Viton seals, the hose reels are especially suitable for fuels. The construction ensures superb strength to serve mobile and permanently mounted applications perfectly. As the hose reels are robust and corrosion resistant, they are ideal for petrochemical applications and other branches of industry. If a hose is ordered, it is assembled with 3/4" BSPT male thread.  
**Advantages:** Robust hose reel for fuels.

code	option	hose length [m]	hose I.D. [inch]	working pressure [bar]	weight [kg]	connection inlet / outlet [BSPT male]	
RC-F7925OLP	with hose	8	3/4	3.5	25	3/4	3/4
RC-F7900OLP	without hose	8	3/4	35	21	3/4	3/4
RC-F83050OLP	with hose	15	3/4	3.5	41	3/4	3/4
RC-F83000OLP	without hose	15	3/4	35	38	3/4	3/4
RC-FD83075OLP	with hose	22	3/4	3.5	59	3/4	3/4
RC-FD83000OLP	without hose	22	3/4	35	41	3/4	3/4
RC-FD84050OLP	with hose	15	1	3.5	55	1	1
RC-FD84000OLP	without hose	15	1	35	41	1	1



### 9000 series

**Material:** Powder coated steel  
**Working temp.:** Up to +65°C

A hose reel intended for compressed air and water. Models designed for fuel and oil are also available. Ideal solution for service vans, permanent service units or plant work areas.  
**Advantages:** Robust construction and base for floor mounting, corrosion resistance.

code	option	hose length [m]	hose I.D. [inch]	working pressure [bar]	weight [kg]	connection inlet / outlet [female]	
RC-D9200OLP	without hose	30	1/2	35	53	1/2" NPT	1/2" NPT
RC-D9299OLP	with hose	30	1/2	21	61	1/2" NPT	1/2" NPT
RC-D9300OLP	without hose	23	3/4	35	53	3/4" BSP	3/4" BSP
RC-D9350OLP	with hose	15	3/4	17	59	3/4" BSP	3/4" BSP
RC-D9305OLP	without hose	30	3/4	35	59	3/4" BSP	3/4" BSP
RC-D9375OLP	with hose	23	3/4	17	69	3/4" BSP	3/4" BSP
RC-D9399OLP	with hose	30	3/4	17	79	3/4" BSP	3/4" BSP
RC-D9400OLP	without hose	15	1	35	53	1" BSP	1" BSP
RC-D9450OLP	with hose	15	1	17	63	1" BSP	1" BSP
RC-D9200OMP	without hose	23	1/2	207	54	1/2" NPT	1/2" NPT
RC-D9275OMP	with hose	23	1/2	137	60	1/2" NPT	1/2" NPT
RC-D9300OMP	without hose	15	3/4	207	54	3/4" BSP	3/4" BSP
RC-D9350OMP	with hose	15	3/4	86	65	3/4" BSP	3/4" BSP

## MACHINES AND ACCESSORIES - hose reels

### REELCRAFT hose reels

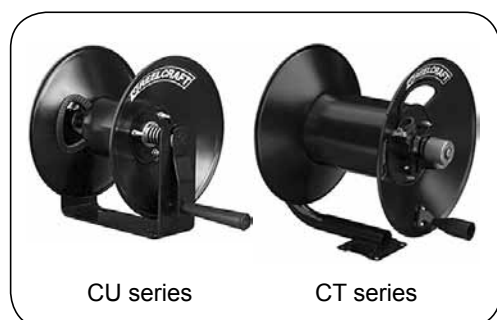

CU series

CT series

### CU / CT series

**Material:** Powder coated steel

**Working temp.:** Up to +65°C

A hand crank hose reel designed for lighter-duty applications transferring air and water. Equipped with a brake to prevent hose unwinding when the reel is not used.

Advantages: Economical hose reel version for hose storing.

code	option	hose length [m]	hose I.D. [inch]	working pressure [bar]	weight [kg]	connection inlet / outlet [NPT female]	
low pressure hose reels							
RC-CU6050LN	without hose	15	3/8	21	5.00	3/8	3/8
RC-CU6100LN	without hose	30	3/8	21	7.00	3/8	3/8
RC-CU8050LN	without hose	15	1/2	21	6.00	1/2	1/2
RC-CU8100LN	without hose	30	1/2	21	9.00	1/2	1/2
high pressure hose reels							
RC-CT605OHN	without hose	15	3/8	345	6.00	1/2	3/8
RC-CT610OHN	without hose	30	3/8	345	7.50	1/2	3/8



### 30000 series - hand crank

**Material:** Powder coated steel

**Working temp.:** From -30°C up to +130°C

A highly durable hose reel, resistant to vibration. All bolted construction, no welded elements. Perfect for long hoses. Hand-driven hose reels are intended for industrial as well as field application. Hoses for 30000 series reels must be ordered separately. BA version, with a bevel crank, is also available. 30000 series hose reels can also be assembled on carts and trailers.

Advantages: Intended for long hoses.

code	for hose length [m]	hose I.D. [inch]	working pressure [bar]	weight [kg]	connection inlet / outlet [BSP female]
RC-CA32106M118	30	1/2	207	18.00	1/2"
RC-CA32112M118	60	1/2	207	21.00	1/2"
RC-CA32118M118	100	1/2	207	25.00	1/2"
RC-CA32128M118	153	1/2	207	30.00	1/2"
RC-CA33112M118	30	3/4	207	21.00	3/4"
RC-CA33118M118	54	3/4	207	25.00	3/4"
RC-CA33128M118	84	3/4	207	30.00	3/4"
RC-CA37118L118	30	1	21	26.00	1"
RC-CA37122L118	38	1	21	28.00	1"
RC-CA37128L118	47	1	21	30.00	1"

# MACHINES AND ACCESSORIES - hose reels

## REELCRAFT hose reels



### 30000 series - motor driven

**Material:** Powder coated steel  
**Working temp.:** From -30°C up to +120°C

30000 series hose reel of a highly durable construction, resistant to vibration. All bolted construction (no welded elements), a large frame and robust drum ensure long service life. Available as a hand crank, pneumatic, hydraulic or electric drive version. Hoses for 30000 series reels must be ordered separately. Advantages: Intended for long hoses.

code	hose length [m]	hose I.D. [inch]	working pressure [bar]	connection inlet / outlet [NPT female]
RC-...32106M...	30	1/2	207	1/2
RC-...32112M...	60	1/2	207	1/2
RC-...32118M...	100	1/2	207	1/2
RC-...32122M...	122	1/2	207	1/2
RC-...32128M...	153	1/2	207	1/2
RC-...33106M...	16	3/4	207	3/4
RC-...33112M...	30	3/4	207	3/4
RC-...33118M...	54	3/4	207	3/4
RC-...33122M...	69	3/4	207	3/4
RC-...33128M...	84	3/4	207	3/4
RC-...37118L...	30	1	21	1

### Construction of the code 30000 series

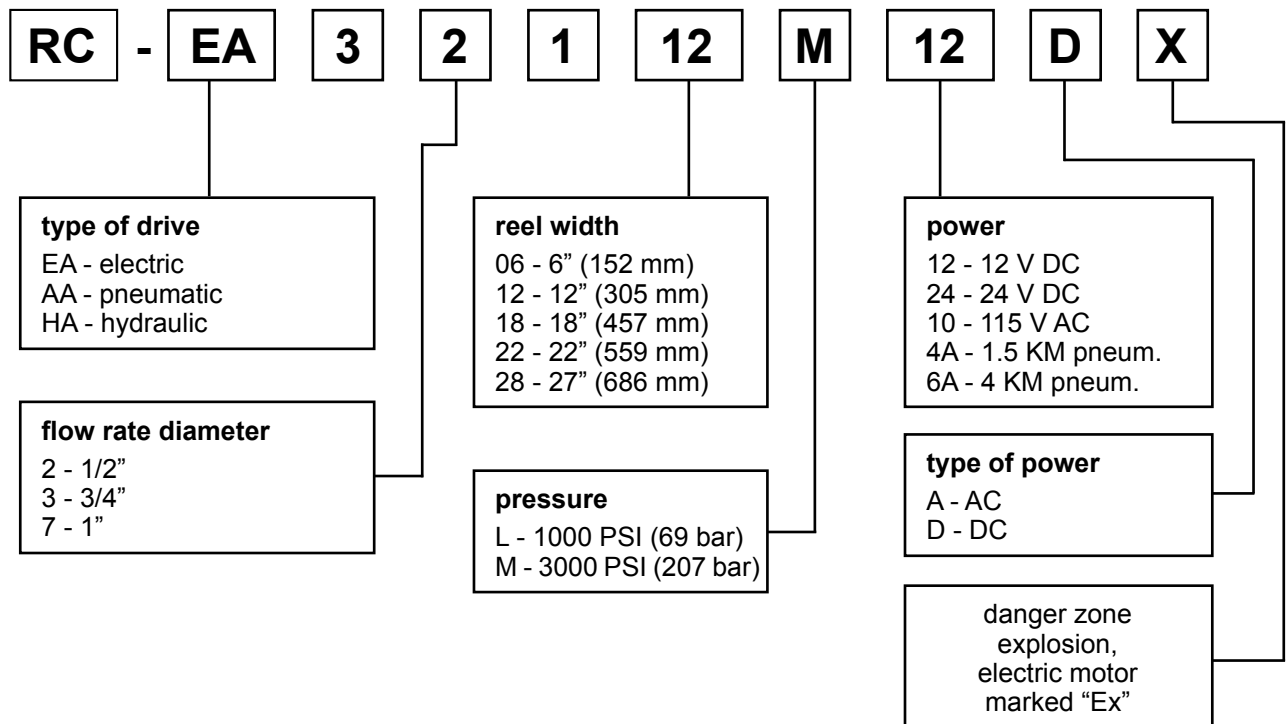

# MACHINES AND ACCESSORIES - hose reels

## REELCRAFT hose reels



### NORDIC™ series

**Material:** Carbon steel, aluminium, stainless steel  
**Working temp.:** From -20°C up to +80°C

Large frame hose reels for hoses with internal diameter up to 4" (100 mm). A wide range of drive options, connections, working pressure and fluid paths. Widely used in petrochemical, ship-building, offshore, construction and mining industry.  
 Advantages: Robust construction, large hose diameters.

drive		series	spool diameter	spool length	thread size		connection type		thread type	
E	12 V DC	1200	19"	6" ÷ 36" (incr. 2")	50	1/2"	F	female out	NP	NPT
NJ	24 V DC	2400	21"		75	3/4"	FF	female in/out	BP	BSP
EP	12 V DC Ex*	3900	23"		10	1"	M	male out	BT	BSPT
EA	115 V AC Ex*	3700	25"		12	1.1/4"	MM	male in/out		
EJ	24 V DC Ex*	5900	28"		15	1.1/2"	V	groove coupling		
HD	hydraulic		31"		20	2"				
AF	pneumatic 1.5 KM		36"		25	2.1/2"				
AR	pneumatic 4 KM		39"		30	3"				
BC	bevel crank		46"		40	4"				
HC	hand crank									

material**		max. working press. [bar]		inlet style		fluid path location/hose direction		colour	
A	aluminium	LP	41	1	straight	1	left hand / top wind	R	red
D	ductile cast iron	1K	69	2	90°	2	left hand / bottom wind	B	black
S	stainless steel	3K	207	5	1" LPG	3	right hand / top wind	W	white
B	bronze	5K	345	6	1.1/2" LPG	4	right hand / bottom wind	G	grey
		6K	414	7	2" LPG			S	silver
		10K	690						

\* - electric explosion proof motor (for use in potentially explosives zones)

\*\* - fluid path material

### Construction of the code NORDIC™ series

## RC- EP3900-23-28-15FFNPALP21-R00

**EP** - 12 V DC electric engine - explosion proof motor version (for use in potentially explosives zones)

**3900** - 3900 series

**23** - 23" drum diameter

**28** - 28" drum length

**15** - 1.1/2" thread size

**FF** - female outlet/female inlet

**NP** - NPT thread

**A** - fluid path material: aluminium

**LP** - working pressure to 41 bar

**2** - 90° inlet style

**1** - fluid path location: left hand; hose direction: top wind

**R** - red

**00** - additional accessories



# MACHINES AND ACCESSORIES - hose reels

## Special purpose REELCRAFT hose reels



### G series

**Material:** Powder coated steel  
**Working temp.:** Up to +65°C

A hose reel intended to secure equipment such as tank trucks or other vehicles transferring flammable materials and operating in hazardous conditions, against electrostatic discharge. When properly grounded, it prevents electrostatic charges build-up thus reduces the risk of sparking and potential explosion. ATEX version available.

Advantages: Small, compact construction

code	length [mm]	width [mm]	height [mm]	cable length [m]	weight [kg]	notes
RC-G3050N	219	85	224	15	5.5	Nylon covered electrical cable.
RC-G3100N	235	110	248	30	10	Nylon covered electrical cable.

## ATEX certified REELCRAFT hose reels



A potentially explosive atmosphere consists of a mixture of air, gases, vapour, mists or dust, which can ignite under particular operation conditions. Potentially explosive atmospheres may occur on oil rigs, in petrochemical plants, mines, flour mills and other areas prone to explosive atmosphere buildup.

Directive 94/9/EC (ATEX) defines the technical requirements and adequate assessment procedures intended to verify the conformity of the equipment and protection systems used in the potentially explosive atmospheres.











Reelcraft hose reels, ATX version (spring driven, hand crank and pneumatic) meet ATEX requirements for electrical equipment:

- spring driven: II 2G c IIC T5 Gb/ II 2D c IIIC T100°C Db,
- hand crank: II 2G c IIC T5 Gb/ II 2D c IIIC T100°C Db,
- pneumatic: II 2G c IIC T4 Gb/ II 2D c IIIC T135°C Db.

Conductive hoses ( $R < 10^6 \Omega/m$ ) must be used with these hose reels.

# MACHINES AND ACCESSORIES - hose reels

## REELCRAFT hose reel accessories

picture	code	description
4000. 5000. 7000 series		
	RC-600626	180° swivel bracket, wall-mounted.
	RC-600608	340° swivel bracket, wall or floor-mounted.
80000. D80000100 series		
	RC-600980	180° swivel bracket, wall-mounted.
30000 series		
  pic. 1                  pic. 2	RC-602328 (pic. 1)	hose reel cart (only for models with a code ending with X106).
	RC-600741-2 (pic. 2)	hose reel cart (only for models with a code ending with X112).
	RC-600885-2 (pic. 2)	hose reel cart (only for models with a code ending with X118).
	RC-600518	chain cover (required for electric, hydraulic and pneumatic drive hose reels).
40 series		
	RC-600952-10	roller guide (only for models with a code 4X2101XX1LC70).
	RC-600952-19	roller guide (only for models with a code 4X2191XX1LC70).
	RC-600953-10	roller guide (only for models with a code 4X2101XX1LC70).
	RC-600953-19	roller guide (only for models with a code 4X2191XX1LC70).
	RC-261746	chain cover (required for electric, hydraulic and pneumatic drive hose reels).
rubber hose bumpers		
	RC-1-HR1004-A	hose external diameter 11.2 x 15.9 mm.
	RC-1-HR1004	hose external diameter 15.9 x 19 mm.
	RC-2-HR1005	hose external diameter 19.2 x 26.7 mm.
	RC-3-HR1005	hose external diameter 26.9 x 35 mm.
	RC-4-HR1005	hose external diameter 35.3 x 39.4 mm.

## MACHINES AND ACCESSORIES - hose reels

### SAURO ROSSI spring retractable reels

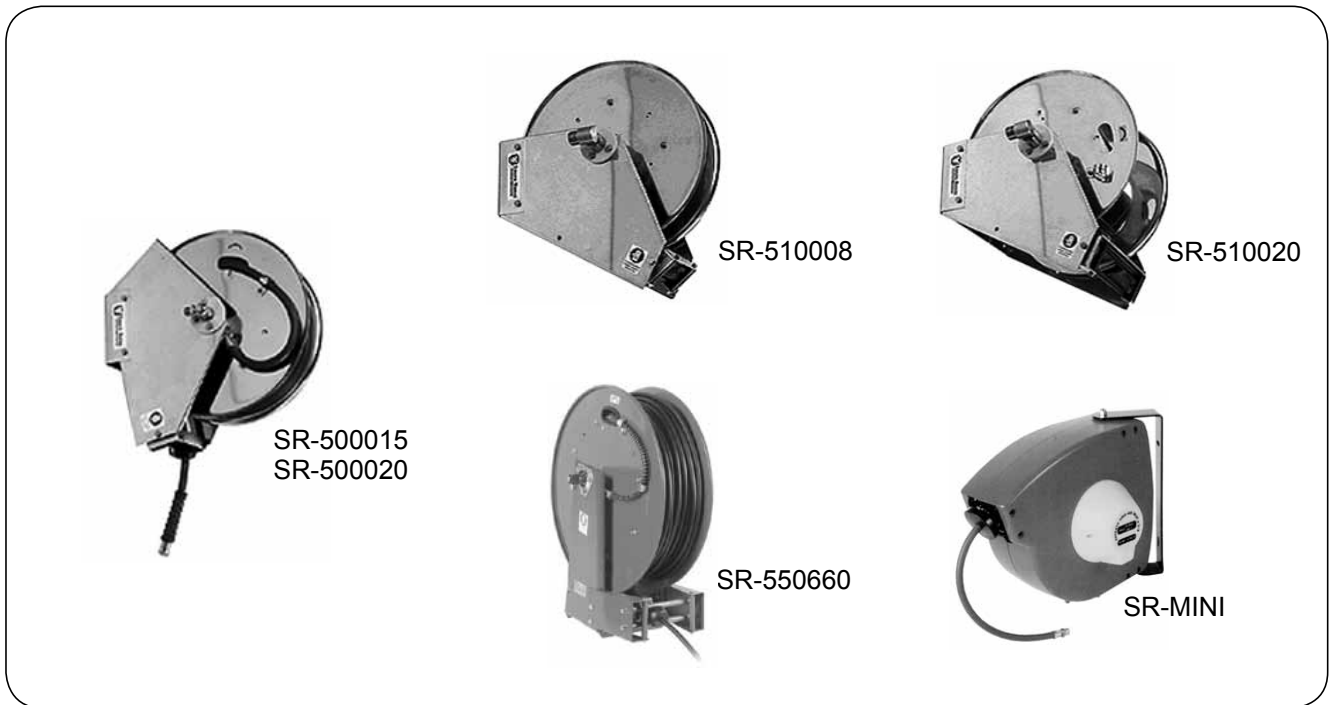

Spring driven reels for transfer of cold and hot water, oil, lubricant and other substances. Widely used in food, chemical industry, production plants, service workshops, dairies, slaughterhouses, farms, petrol stations, sewage treatment plant applications. Reels have a spring driven mechanism that allows a complete retraction each time it is slightly pulled out. A MINI series hose reel is available with a PVC hose designed for air and water in the temperature range from -10°C up to +60°C. Other models are supplied without hose. Swing bracket available as a separate item.

code	working pressure [bar]	thread inlet [inch]	thread outlet [inch]	hose I.D. [inch]	for hose length [m]	material*
SR-500015-A	250	1/2 male	1/2 female	1/2	15	galvanized steel
SR-500015-X	250	1/2 male	1/2 female	1/2	15	AISI 304
SR-500020-A	250	1/2 male	1/2 female	1/2	25	galvanized steel
SR-500020-X	250	1/2 male	1/2 female	1/2	25	AISI 304
SR-510008-A	200	1 male	1 female	1	10	galvanized steel
SR-510008-X	200	1 male	1 female	1	10	AISI 304
SR-510020-A	200	1 male	1 female	1	20	galvanized steel
SR-510020-X	200	1 male	1 female	1	20	AISI 304
SR-550660-A	250	1/2 male	3/8 female	3/8	70	galvanized steel
SR-550660-X	250	1/2 female	3/8 female	3/8	70	AISI 304
SR-MINI	30	1/4 female	1/4 male	8x12 mm	15	PVC
SR-968002-F	swing bracket for SR-550660-A					
SR-968002-X	swing bracket for SR-550660-X					
SR-968003-F	swing bracket for SR-500015-A, SR-500020-A, SR-510008-A					
SR-968003-X	swing bracket for SR-500015-X, SR-500020-X, SR-510008-X					
SR-968004-F	swing bracket for SR-510020-A					
SR-968004-X	swing bracket for SR-510020-X					

\* - reels made of powder coated galvanized steel are available in red colour

# MACHINES AND ACCESSORIES - hose reels

## ECODORA spring retractable reels



### 430 / 530 / 540 / 560 series

**Material:** Carbon steel  
**Seal:** Viton  
**Working temp.:** Up to +130°C

Spring driven hose reels designed to transfer cold and hot water, oil, lubricants and other media. Equipped with a spring tested to 25000 cycles (reel in/reel out). Complies to ATEX Directive 94/9 IIB 2GD c T4 T135C X. A hose is not included, must be ordered separately. A swing bracket is available as a separate item. Advantages: AISI 304 steel swivel coupling, Viton seal.

code	hose length [m]	hose I.D. [inch]	working pressure [bar]	efficiency [l/min]	connection inlet / outlet [BSP female]	
ED-430-20	15	1/2	150	75	1/2"	1/2"
ED-530-20	25	1/2	150	75	1/2"	1/2"
ED-540-25	30	1/2	150	75	1/2	1/2
ED-540-20	20	3/4	150	150	1"	1"
ED-560-20	30	1	150	150	1"	1"
ED-430-30	18	3/8	200	30	3/8"	1/2"
ED-540-30	30	3/8	200	30	3/8"	1/2"
ED-430-05	swing bracket for 430 series					
ED-530-05	swing bracket for 530 series					
ED-540-05	swing bracket for 540 series					

Basic dimensions of different series:

	series	A	B	C	D	E	F	G	H
	430	186	140	196	226	115	450	420	460
	530	203	153	220	258	115	550	510	560
	540	300	218	228	268	190	550	510	573
	560	488	399	238	272	368	522	510	578

# MACHINES AND ACCESSORIES - hose reels

## ECODORA spring retractable reels



### 304 / 354 / 434 / 534 / 544 / 564 series

**Material:** AISI 304 stainless steel  
**Working temp.:** Up to +130°C

Hose reels designed for food, chemical industry as well as applications where corrosion may affect metal parts. Equipped with a spring tested to 25000 cycles (reel in/reel out). Complies to ATEX Directive 94/9 IIB 2GD c T4 T135C X. A hose is not included, must be ordered separately. A swing bracket is available as a separate item. Available as a stainless steel version (all parts made of AISI 316) or with a stainless steel fluid path. Advantages: Durability, operation safety, user-friendly.

code	hose length [m]	hose I.D. [inch]	working pressure [bar]	efficiency [l/min]	sealing	connection inlet / outlet [BSP female]	
ED-304-40	8	1/2	150	60	Viton	1/2"	1/2"
ED-354-40	17	3/8	150	60	Viton	1/2"	1/2"
ED-434-20	15	1/2	150	75	Viton	1/2"	1/2"
ED-534-20	25	1/2	150	75	Viton	1/2"	1/2"
ED-544-25	30	1/2	150	75	Viton	1/2"	1/2"
ED-544-20	20	3/4	150	150	Viton	1"	1"
ED-564-20	30	1	150	150	Viton	1"	1"
ED-434-30	18	3/8	200	30	Viton	3/8"	1/2"
ED-544-30	30	3/8	200	30	Viton	3/8"	1/2"
ED-534-35	25	3/8	400	40	PTFE	3/8"	1/2"
ED-564-35	50	3/8	400	40	PTFE	3/8"	1/2"
ED-430-06	swing bracket for 434 series						
ED-540-06	swing bracket for 544 series						
ED-530-06	swing bracket for 534 series						

### Basic dimensions of different series:

series	A	B	C	D	E	F	G	H
304	186	140	196	226	110	355	350	365
354	186	140	196	226	110	400	390	410
434	186	140	196	226	115	450	420	460
534	203	153	220	258	115	550	510	560
544	300	218	228	268	190	550	510	573
564	488	399	238	272	368	522	510	578

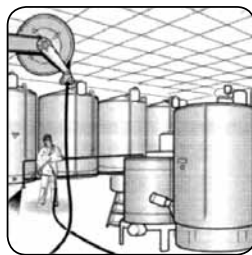
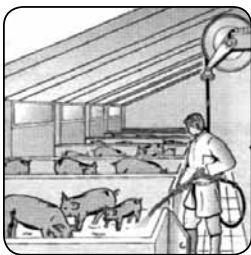

## MACHINES AND ACCESSORIES - hose reels

### EZ-COIL spring retractable reels

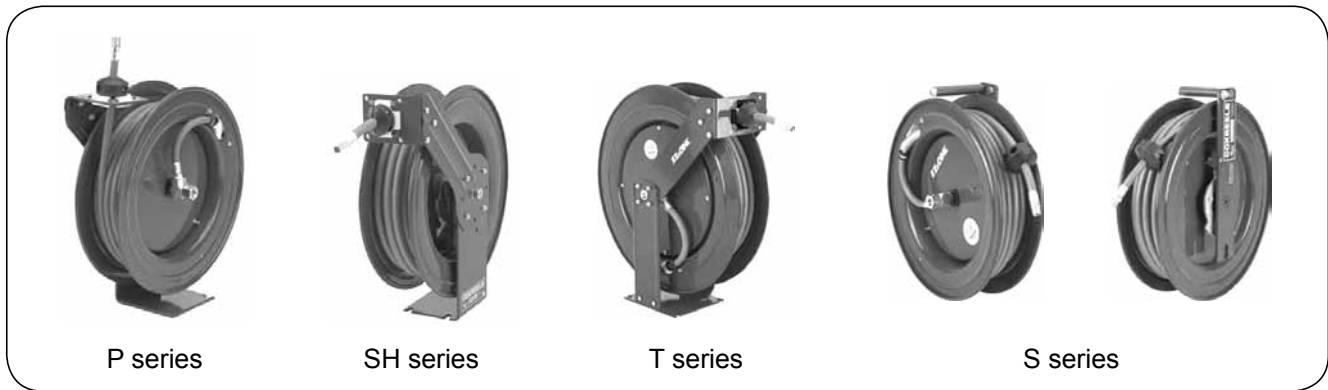

Powder coated (blue colour) carbon steel hose reels designed for food, chemical industry as well as production plants, service stations, etc. Equipped with a patented controlled retraction system - EZ-Coil® that retracts up to 80% slower than conventional spring driven reels. The EZ-Coil® was specifically designed and introduced to reduce workplace accidents, increase operator safety, extend hose, swivel and hose reel service life. A hose is connected directly to a swivel that facilitates assembly. The hose is not included, must be ordered separately. Advantages: Increased operation and work safety compared to standard spring driven hose reels.

series	code	hose length [m]	hose I.D. [inch]	working pressure [bar]	connection inlet / outlet [BSP]	weight without hose [kg]
P	CR-EZ-P-LPL-350-BGX	15	3/8"	21	3/8"	16.00
	CR-EZ-P-LPL-450-BGX	15	1/2"	21	1/2"	22.00
	CR-EZ-P-HPL-125-BGX	9	1/4"	350	1/4"	20.00
SH	CR-EZ-SHL-4100-BGX	31	1/2"	21	1/2"	30.00
	CR-EZ-SHL-550-BGX	15	3/4"	21	3/4"	25.00
	CR-EZ-MPL-350-BGX	15	3/8"	210	3/8"	24.00
T	CR-EZ-TSHL-4100-BGX	30	1/2"	21	1/2"	36.00
	CR-EZ-TMPL-550-BGX	15	3/4"	105	3/4"	34.00
	CR-EZ-THPL-350-BGX	15	3/8"	280	3/8"	30.00
S-left	CR-EZ-SL15L-L325-BGX	8	3/8"	21	3/8"	8.00
	CR-EZ-SL19L-L450-BGX	15	1/2"	21	1/2"	13.00