

INDUSTRIAL FITTINGS - quick release couplings

HANSEN BEVERAGE PRODUCTS couplings for food industry



TUBES INTERNATIONAL® supplies HANSEN BEVERAGE PRODUCTS couplings. This name stands for a group of couplings that are widely used in food and pharmaceutical industry. They are used by leading dairy producers. The couplings are usually made of acid-resistant steel, can be used for gas and fluid (depending on the series). Spare parts for these couplings (valves, seals, springs etc.) are also available in our offer. For proper coupling selection, please try to specify its application precisely and contact Sales or Technical Department of TUBES INTERNATIONAL®

INDUSTRIAL FITTINGS - quick release couplings

HANSEN BEVERAGE PRODUCTS couplings for food industry

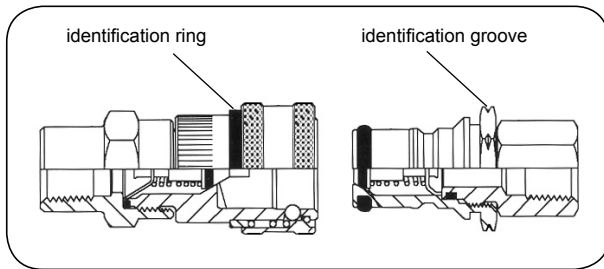
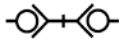

2HG / 2HL series

Working press.: 15 bar
Working temp.: Up to +130°C

All parts in contact with the medium are made of acid-resistant steel. The couplings are available in two versions: for gases and for fluids. These two versions are not interchangeable (different plug dimension), to avoid wrong connection. Easy to distinguish. Couplings for gases - white identification ring on a socket and a groove on the hexagon of a plug. Couplings for fluids - black identification ring on a coupling and a lack of groove on the hexagon of a plug.

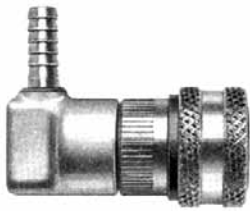
	code	hose I.D. [inch]	medium	description
	HB-2HGRB	1/4	gases	90° socket with hose tail.
	HB-2HLRB	1/4	liquids	

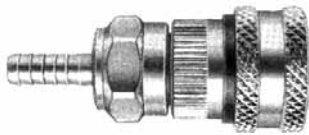
	code	hose I.D. [inch]	medium	description
	HB-2HGBNB	1/4	gases	Socket with hose tail.
	HB-2HGDNB	3/8		
	HB-2HLBNB	1/4	liquids	
HB-2HLDNB	3/8			

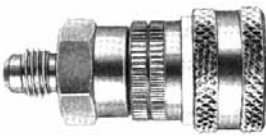
	code	thread size [inch]	medium	description
	HB-2HG720	7/16-20	gases	Socket with an UNF male thread (90° cone).
	HB-2HL720	7/16-20	liquids	

	code	thread size [inch]	medium	description
	HB-2HGLLRA720	7/16-20	gases	90° socket with an UNF male thread (90° cone)..
	HB-2HLLRA720	7/16-20	liquids	











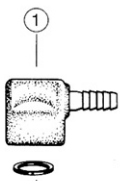
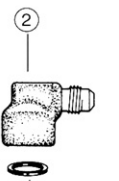

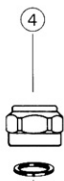



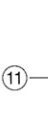

INDUSTRIAL FITTINGS - quick release couplings

HANSEN BEVERAGE PRODUCTS couplings for food industry

	code	thread size [inch]	medium	description
	HB-2HG15	1/4	gases	Socket with a NPT male thread.
	HB-2HG20	3/8		
	HB-2HL15	1/4	liquids	
HB-2HL20	3/8			

	code	thread size [inch]	medium	description
	HB-2HG16	1/4	gases	Socket with a NPT female thread.
HB-2HL16	1/4	liquids		





	code	medium	description
	HB-LN2HGA	gases	Socket without valve.
	HB-LN2HGB		Socket with a valve.
	HB-LN2HGC		Socket with a valve and seal.
	HB-LN2HLA	liquids	Socket without valve.
	HB-LN2HLB		Socket with a valve.
HB-LN2HLC	Socket with a valve and seal.		

2-HG and 2-HL socket components		
pic.	code	description
	HB-SE2HGLRB	90° connection with 1/4" hose tail
	HB-SE2HGLLRA720	90° connection with male thread 7/16"-20 UNF
	HB-SE2HGLBNB	1/4" hose tail + nut
	HB-SE2HGLDN	Nut for a fitting with hose tail
	HB-W2HGL1	Rubber seal
	HB-SE2HGLBNB1	1/4" hose tail
	HB-SE2HGLDNB1	3/8" hose tail
	HB-SE2HGL15	Connection with 1/4" NPT male thread x 11/16-18 UNF female thread
	HB-SE2HGL20	Connection with 3/8" NPT male thread x 11/16-18 UNF female thread
	HB-SE2HGL720	Connection with 7/16-20 UNF male thread x 11/16-18 UNF female thread
	HB-SE2HGL16	Connection with 1/4" NPT female thread x 11/16-18 UNF female thread
	HB-4BSVAB	Valve
	HB-2HG01A	Socket body for gases
	HB-2HL01A	Socket body for liquids
	HB-2HGL01B1	White identification ring (gases)
	HB-2HGL01B2	Black identification ring (liquids)
	HB-2104A302	Locking balls (3 pieces)
	HB-3S05	Ferrule spring
	HB-2HGL02	Ferrule
	HB-3S06	Retaining ring

INDUSTRIAL FITTINGS - quick release couplings



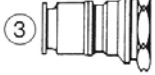



HANSEN BEVERAGE PRODUCTS couplings for food industry

	code	thread size [inch]	medium	description
	HB-2KGF	9/16-18 UNF	gases	Plug.
	HB-2KLF	5/8-18 UNF	liquids	

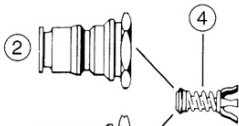
2-KG-F and 2-KL-F plug components		
pic.	code	description
	HB-902-9-292	O-ring.
	HB-2KG01F	Plug body 9/16-18 UNF female thread (gases)
	HB-2KL01F	Plug body 5/8-18 UNF female thread (liquids)
	HB-VA2KGLFA	Valve

	code	thread size [inch]	medium	description
	HB-2KGF16	1/4 NPT	gases	Plug with female thread.
	HB-2KGF720	7/16-20 UNF		
	HB-2KLF16	1/4 NPT	liquids	
HB-2KLF720	7/16-20 UNF			

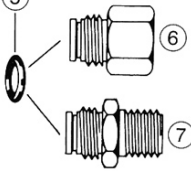
	code	thread size [inch]	medium	description
	HB-2KGF15	1/4 NPT	gases	Plug with male thread.
	HB-2KGF20	3/8 NPT		
	HB-2KLF15	1/4 NPT	liquids	
HB-2KLF20	3/8 NPT			

2-KG-F and 2-KL-F plug components		
pic.	code	description
	HB-9029292	O-ring
	HB-2KL01F	Plug body 5/8-18 UNF female thread (liquids)
	HB-2KG01F	Plug body 9/16-18 UNF female thread (gases)
	HB-VA2KGLFA	Valve
	HB-9027292	O-ring
	HB-PE2KGF1601	Connection with 1/4" NPT female thread (plug 2KG-F16, liquids)
	HB-PE2KLF1601	connection with 1/4" NPT female thread (plug 2KG-F16, gases)
	HB-PE2KGF72001	Connection with 7/16-20 UNF female thread (plug 2KG-F720, liquids)
	HB-PE2KLF72001	Connection with 7/16-20 UNF female thread (plug 2KG-F720, gases)
	HB-PE2KGF1501	Connection with 1/4" NPT male thread (plug 2KG-F15, liquids)
	HB-PE2KLF1501	Connection with 1/4" NPT male thread (plug 2KG-F15, gases)
	HB-PE2KGF2001	Connection with 3/8" NPT male thread (plug 2KG-F20, liquids)
	HB-PE2KLF2001	Connection with 3/8" NPT male thread (plug 2KG-F20, gases)

INDUSTRIAL FITTINGS - quick release couplings

HANSEN BEVERAGE PRODUCTS couplings for food industry

	code	thread size [inch]	medium	description
	HB-2KGC	11/16-18 UNF	gases	Plug without connection part with plastic insert.
	HB-2KLC	3/4-18 UNF	liquids	

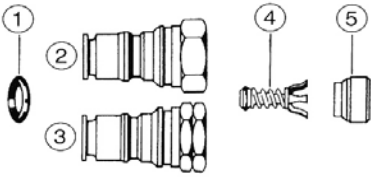
2-KG-C and 2-KL-C plug components			
pic.	code	description	
	1	HB-902-9-292	O-ring.
	2	HB-2KL01C	Plug body with a fem. thread 3/4-18 UNF (liquids).
	3	HB-2KG01C	Plug body with a fem. thread 11/16-18 UNF (gases).
	4	HB-PVA372381	Valve.
	5	HB-NPI3723	Plastic insert.

	code	thread size [inch]	medium	description
	HB-2KGCRN	19/32-18 UNF	gases	Plug without connection part.
	HB-2KLCRN	19/32-18 UNF	liquids	

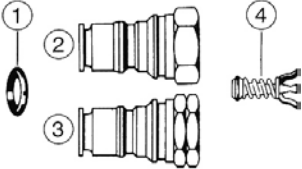
2-KG-CRN and 2-KL-CRN plug components			
pic.	code	description	
	1	HB-902-9-292	O-ring.
	2	HB-2KG01CRN	Plug body with a fem. thread 19/32-18 UNF (gases).
	3	HB-2KL01CRN	Plug body with a fem. thread 19/32-18 UNF (liquids).
	4	HB-VA2KGLCRN	Valve.